



**BLUINTERNI**<sup>®</sup>  
ITALIAN ARCHITECTURAL DOORS

**MANUALE TECNICO - TECHNICAL MANUAL**



# BOISERIE

**\_VERTICAL**

**\_HORIZONTAL**

FIAM s.r.l. - Via Castellana, 15 31010 Cimadolmo (TV) Italy  
Tel. +39 0422 748839  
[www.bluinterni.it](http://www.bluinterni.it) - [info@bluinterni.it](mailto:info@bluinterni.it)

## Boiserie su telaio B-Line a Spingere / Boiserie on B-Line Push frame

Montaggio telaio su cartongesso  
Frame assembly on plasterboard

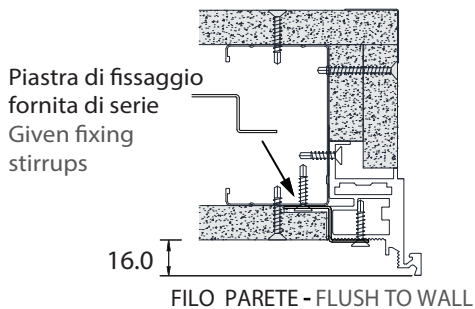

Aggancio boiserie su cartongesso  
Boiserie hanging on plasterboard

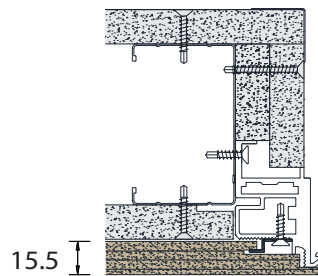

Montaggio telaio su muratura  
Frame assembly on brickwall

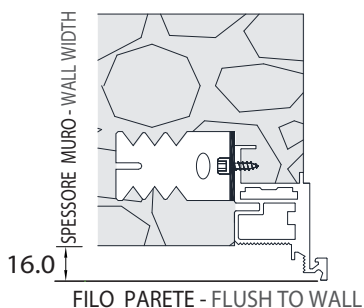

Aggancio boiserie su muratura  
Boiserie hanging on brickwall

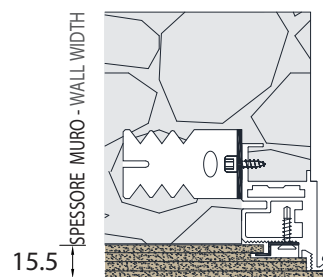

## Boiserie su telaio B-Line a Tirare / Boiserie on B-Line Pull frame

Montaggio telaio su cartongesso  
Frame assembly on plasterboard

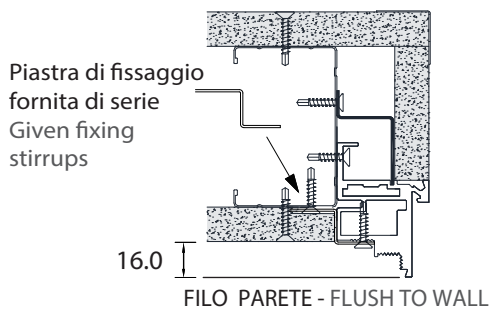

Aggancio boiserie su cartongesso  
Boiserie hanging on plasterboard

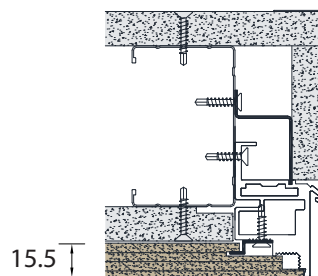

Montaggio telaio su muratura  
Frame assembly on brickwall

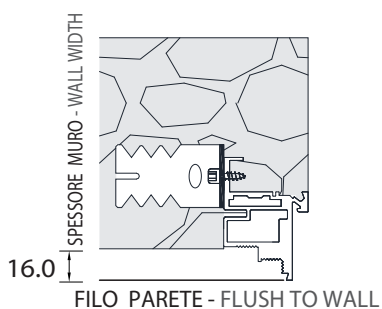

Aggancio boiserie su muratura  
Boiserie hanging on brickwall

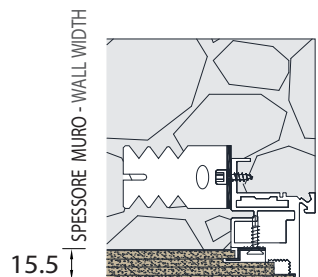

## Clip di fissaggio / Fixing clip

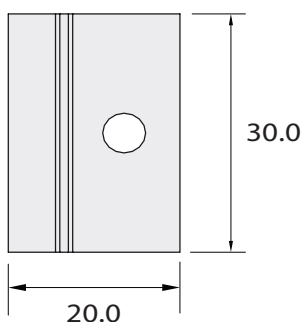

Dimensioni  
Dimensions

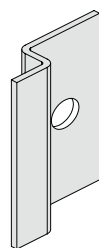
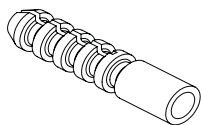

Fissaggio su muro  
Fixing on wall

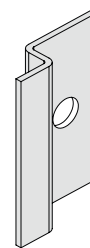
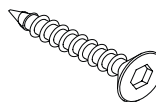

Fissaggio su cartongesso  
Fixing on plasterboard

## Pannello / Panel

Finitura in essenza, e tutti i materiali applicati:  
Wood finishing and all applied materials:

Pannello in multistrati di Okoumè resistente all'acqua con applicata la finitura su un lato

Waterproof multilayer Okoumè panel with finishing applied on one side

15.5



Lato del pannello con la finitura  
Panel side with finishing



Finitura laccato opaco / lucido:  
Matt/Glossy lacquered finishing:

Pannello in MDF idrofugo con poliester

Waterproof MDF with polyester panel

15.5



Lato del pannello con la finitura  
Panel side with finishing

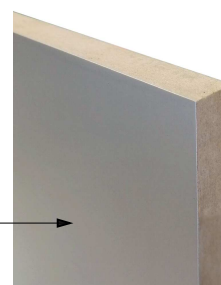

Le dimensioni in larghezza dei pannelli saranno definite da Bluinterni in base alla composizione della parete  
Dimensions in width will be decided by Bluinterni according to wall composition

Per dimensioni in altezza oltre mm 3000 il pannello sarà in MDF Idrofugo (NON in multistrati)  
For dimensions higher than mm 3000, the panel will be in Waterproof MDF (NOT multilayer)

## Pannello con specchio / Panel with mirror

Pannello in mulistrati di Okoumè resistente all'acqua con applicato Specchio su un lato  
Waterproof multilayer Okoumè panel with mirror applied on one side



---

## Lastra di Gres / Gres sheet

Pannello Boiserie in Gres viene fornito senza supporto in Okoumè, ma la sola lastra da incollare alla parete

The Gres Boiserie panel is supplied without okoumè panel, but only the sheet to be glued on the wall



\* Spessore lastra Gres Opaco mm 3.5  
\* Thickness of the matt Gres sheet mm 3.5

\* Spessore lastra Gres Lucido mm 5.5  
\* Thickness of the glossy Gres sheet mm 5.5

# Istruzioni di incollaggio dei pannelli boiserie

## Boiserie panels gluing instructions

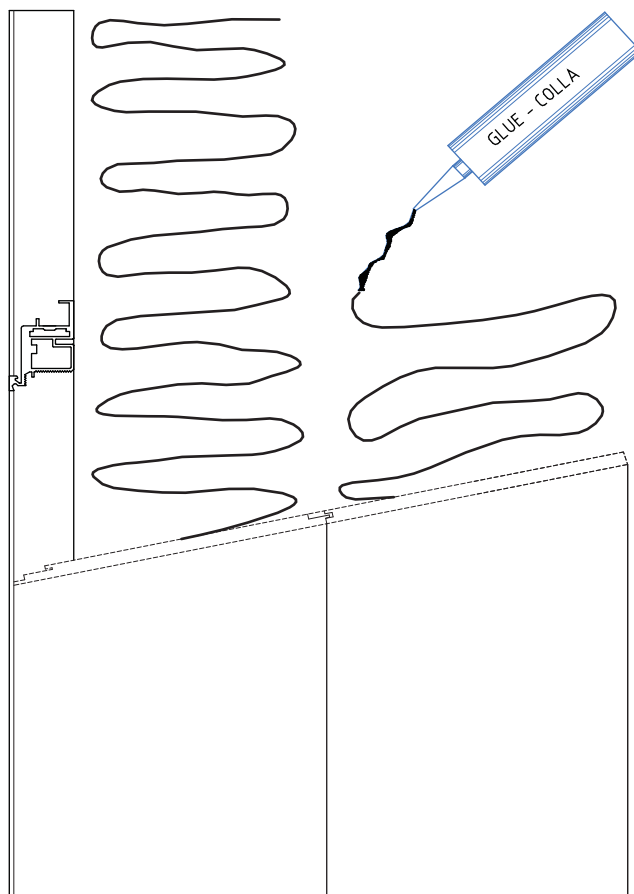
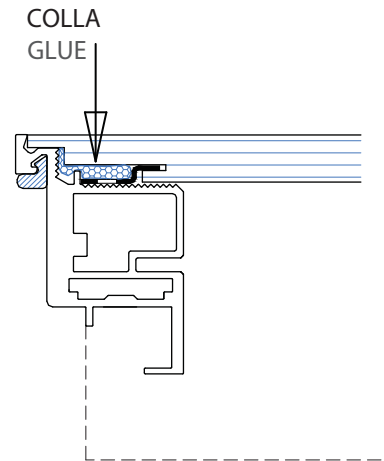
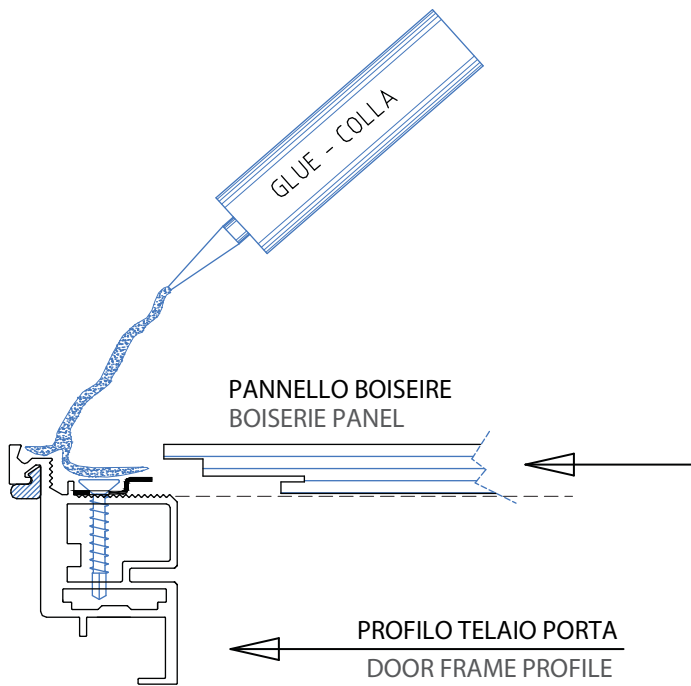

LA COLLA PER APPLICARE  
I PANNELLI BOISERIE ALLA  
PARETE NON VIENE FORNITA

THE GLUE TO APPLY BOISERIE  
PANELS IS NOT PROVIDED

## Boiserie Verticale / Vertical Boiserie

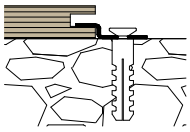

Installazione pannello iniziale Boiserie-V  
Installation of the starting panel Boiserie-V

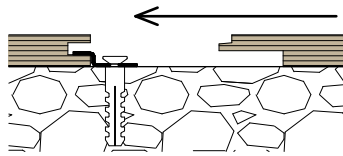

Ancoraggio pannello iniziale Boiserie-V  
Anchor of the starting panel Boiserie-V

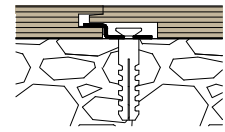

Installazione pannelli successivi Boiserie-V  
Installation of following panels Boiserie-V



### Guarnizione / Trim

Guarnizione che isola il pannello dal pavimento  
Trim insulating panel from floor

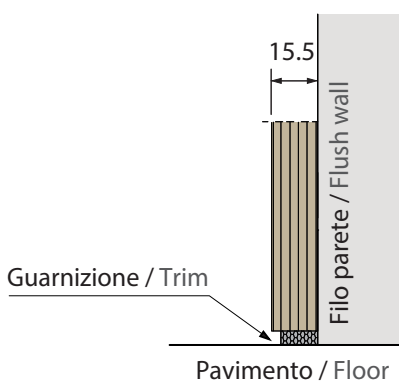

### Fissaggio / Fix

I pannelli boiserie devono essere fissati con le clips fornite in dotazione e incollati con apposita colla

Boiserie panels shall be fixed with given clips and glued with adapt glue

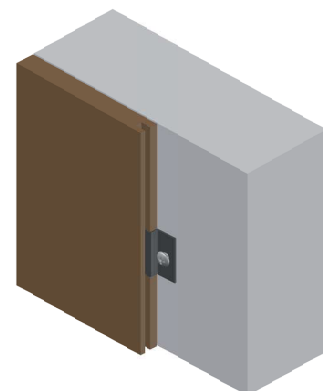
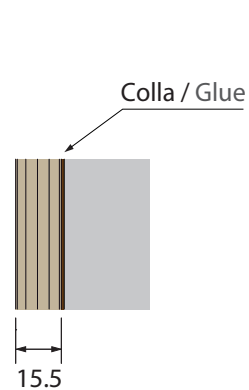

## Boiserie Orizzontale / Horizontal Boiserie

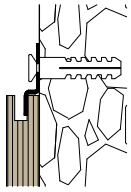

Installazione pannello iniziale Boiserie-H  
Installation of the starting panel Boiserie-H

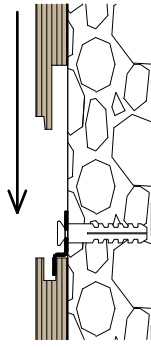

Ancoraggio pannello iniziale Boiserie-H  
Anchor of the starting panel Boiserie-H

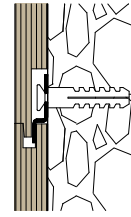

Installazione pannelli successivi Boiserie-H  
Installation of following panels Boiserie-H



### Guarnizione / Trim

Guarnizione che isola il pannello dal pavimento  
Trim insulating panel from floor

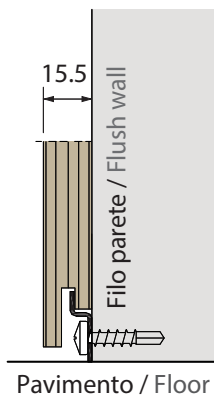

### Fissaggio / Fixing

I pannelli boiserie devono essere fissati con le clips fornite in dotazione e incollati con apposita colla  
Boiserie panels shall be fixed with given clips and glued with adapt glue

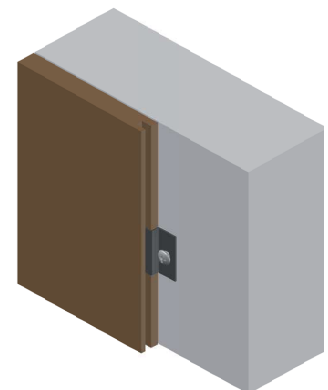
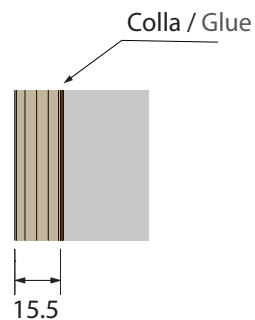

## Bordi e angoli Boiserie / Boiserie edges and corners

Boiserie è un sistema per il rivestimento delle pareti in cui pannelli vanno incollati e fissati al muro e possono essere sezionati a misura sul posto.

C'è la possibilità di finire i bordi e gli angoli come da illustrazioni.

Boiserie is a wall covering system where panels have to be glued and fixed to the wall and can be cut on site.

Edges and corners can be ended as drawn.



Pannello di chiusura bordato in verticale  
Edges closing panel



Profilo in alluminio laccato in tinta per la chiusura terminale  
Matched lacquered aluminium profile for ending closing



Pannello assemblato a 45° con un lato di dimensione max 150 mm e con un rinforzo in alluminio

45° assembled panel with one side maximum dimension 150 mm and with aluminium reinforce



Pannello assemblato a 90° con bordo in vena  
90° assembled panel edged in vertical



## Descrizione finiture Standard / Standard finishing description

FINITURA / FINISHING	DESCRIZIONE / DESCRIPTION	
Laccato Opaco / Lucido Matt / Glossy lacquered	Laccato opaco 10 gloss / Lucido spazzolato su base poliestere levigato Matt lacquered 10 gloss / glossy on a polished polyester base	
Rovere naturale Natural oak	Tranciato di rovere naturale 6/10 rigatino con finitura acrilica 5 gloss Straight grain veneer mm 0.6 of natural oak with acrylic finishing 5 gloss	
Rovere Artic / Scuro Artic / Dark oak	Tranciato di rovere pretinto 6/10 rigatino verticale con finitura acrilica 5 gloss Vertical straight grain veneer mm 0.6 of pre-dyed oak with acrylic finishing 5 gloss	*
Rovere laccato Lacquered oak	Tranciato di rovere naturale 6/10 rigatino con laccato a poro aperto 10 gloss Straight grain veneer mm 0.6 of natural oak with open pore lacquer 10 gloss	
Rovere antico naturale Antique natural oak	Tranciato di rovere antico 10/10 spazzolato e con finitura acrilica 5 gloss Antique oak veneer mm 1.0 brushed and with acrylic finishing 5 gloss	
Noce canaletto American walnut	Tranciato di noce canaletto 6/10 con finitura acrilica 5 gloss Veneer mm 0.6 of american walnut with acrylic finishing 5 gloss	
Noce canaletto numerato Matched american walnut	Tranciato di noce canaletto 6/10 con finitura acrilica 5 gloss. La numerazione è prevista quando si deve abbinare con una boiserie e deve rispettare la continuazione della vena orizzontale Veneer mm 0.6 of american walnut with acrylic finishing 5 gloss. Matching is recommend when there is the need to match a boiserie and continuing the horizontal vein	
Frassino Oliva Olive ash	Tranciato di frassino pretinto 6/10 verticale con finitura acrilica 5 gloss Vertical pre-dyed ash veneer mm 0.6 of with acrylic finishing 5 gloss.	*
Frassino Matè Matè ash	Tranciato di frassino 10/10 verticale con lavorazioni superficiali, tinta a straccio, finitura acrilica 5 gloss Vertical ash veneer mm 1.0, with treatment on surface, stained varnish and acrylic finishing 5 gloss	
Alutes Alutes	Tessuto spalmato con una lamina di alluminio superficiale Tissue spread on an aluminium layer	
Ecocuoio Eco-leather	Ecocuoio con cuciture in tinta o in contrasto applicato a moduli (vedi pag. 9) Eco-leather with matching or in contrast steaches, modular applied (see page 9)	
Pietra Stone	Pietra naturale supportata applicata in foglio unico o a moduli (vedi pag. 9), finitura protettiva 5 gloss Natural stone with support available in a single sheet or in a modular (see pag. 9), with protective acrylic finishing 5 gloss.	
Specchio Vetro laccato Mirror Lacquered glass	Specchio Argento / Bronzo da mm 4 con pellicola antinfortunistica Vetro trasparente / satinato retrolaccato da mm 4.0 con pellicola antinfortunistica Silver / Bronzed 4 mm mirror with safety film Transparent / Satin glass lacquered 4.0 mm with safety film	
Gres Gres	Gres porcellanato opaco da mm 3.5 e lucido da mm 5.5 (senza pannello di supporto in multistrati) Gres matt of 3.5 mm and glossy of 5.5 mm (without multilayer panel as support)	

Orizzontale - Standard  
Horizontal - Standard



Verticale - Su richiesta  
Vertical - On request

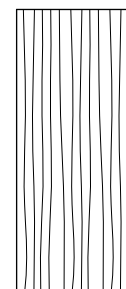

\* Solo tranciato verticale  
Only vertical veneer

## Boiserie in Ecocuoio / Ecoleather boiserie

Su questi pannelli Boiserie sono presenti diversi dettagli di pregio, tra cui le cuciture a vista, che possono essere fornite in tinta o in contrasto e che suddividono la superficie e valorizzano i materiali. La geometria dei riquadri determinata dalle cuciture viene proporzionata a seconda della dimensione del pannello, come illustrato dai disegni.

These panels Boiserie present high quality details, as steaches, that can be supplied the same colour as the eco-leather or in contrast. Steaches divides surface and value materials. Square made by steaches is proportional to panel dimensions, as shown on drawing below.

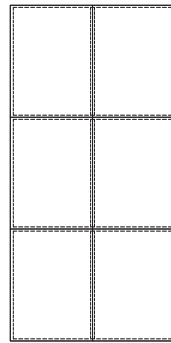
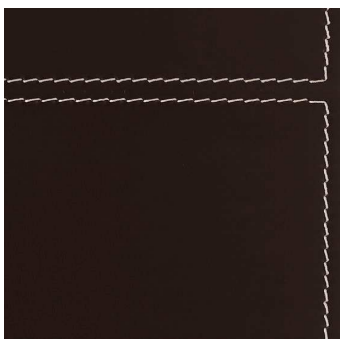

2400

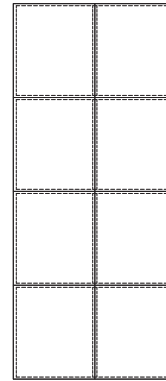

2700

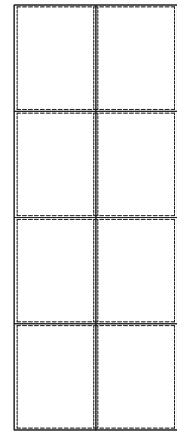

3000

## Porta in Pietra / Stone door

Le divisioni geometriche in settori sono dovute ai vincoli dimensionali di reperibilità della pietra naturale.

The availability of the natural stone oblige to geometric sector.

### Ocean black

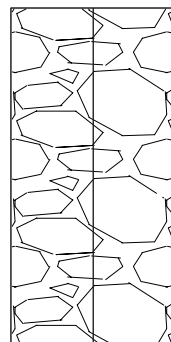

2400

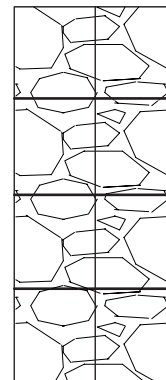

2700

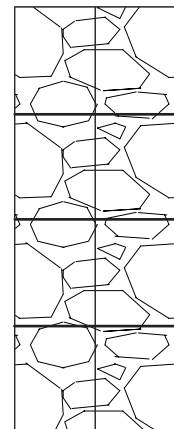

3000

### Silver shine



Oltre H 2400 i settori in pietra sono divisi con listelli da mm 6 laccati in tinta  
For panels higher than 2400, stone sectors are divided with 6 mm thickness  
match lacquered slats

Per le "Caratteristiche della pietra" **NON** contestabili si veda l'apposito documento  
For "Stone features" **NOT** questionable, see detailed document



# **BLUINTERNI**<sup>®</sup>

ITALIAN ARCHITECTURAL DOORS

---

FIAM s.r.l. - Via Castellana, 15 31010 Cimadolmo (TV) Italy

Tel. +39 0422 748839

[www.bluinterni.it](http://www.bluinterni.it) - [info@bluinterni.it](mailto:info@bluinterni.it)

---

**BLUINTERNI si riserva di modificare il presente manuale tecnico senza preavviso alcuno.**

**BLUINTERNI has the right to modify this technical manual without notice.**

05/09/2023 BLUINTERNI-tutti i diritti sono riservati. Sono vietati l'uso e la riproduzione anche parziale, con qualsiasi mezzo di testi e immagini contenuti in questo stampato.

05/09/2023 BLUINTERNI-all rights are reserved. Use copy, even partial, through any means of text or images, is forbidden