

Open
new doors,
create
new spaces.

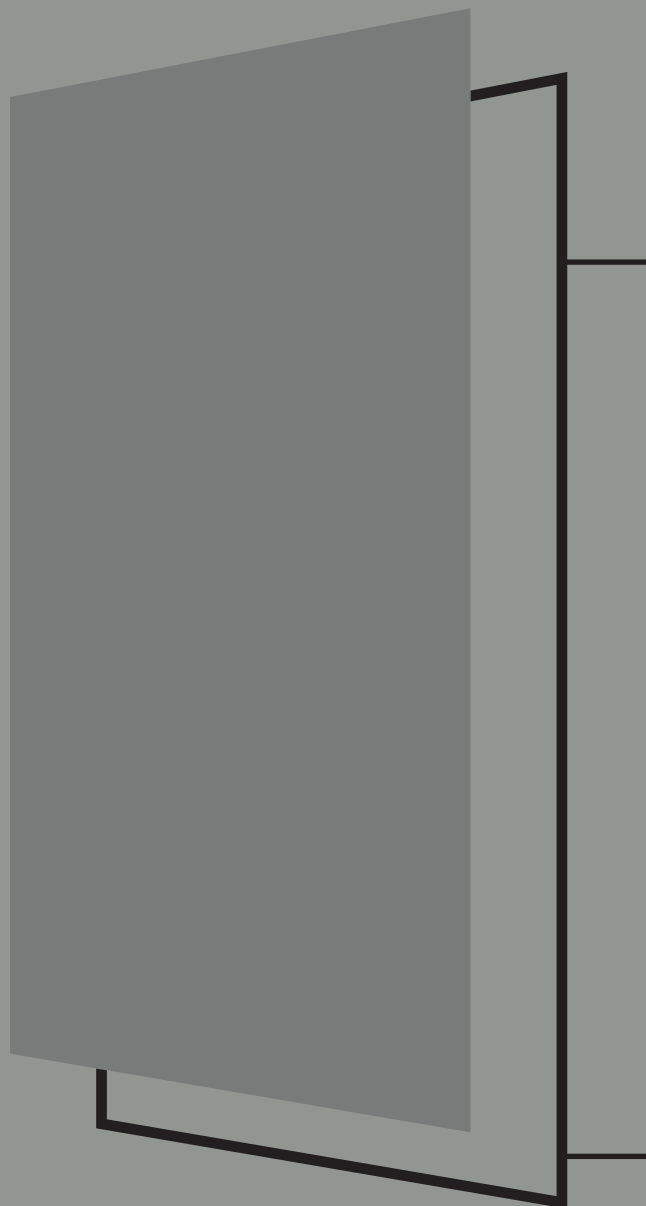

BLUINTERNI®
ITALIAN ARCHITECTURAL DOORS

**Porte
di qualità
e design
per progetti
unici e di stile.**

**Quality
doors & design
for unique
projects & styles.**

Indice

Contents

Battenti

swing doors

B-Line

aperture - openings

Anta - Door

Plana	> 006
Folding	> 044
Twist	> 078
Wall	> 096
Dual	> 100
Queen	> 106
King	> 112

> 004

B-Frame

aperture - openings

Anta - Door

Plana	> 126
Queen	> 136

> 124

Boiserie

aperture - openings

Anta - door

Plana

> 142

Bilico

pivot doors

B-Lico

aperture - openings

Anta - Door

B 52	> 162
Mono 45	> 170

> 158

Scorrevoli

sliding doors

B-Move

Sistema di scorrimento
Sliding system

Sky	> 174
Basic	> 188
Luce-B / Luce-S	> 194
Multy / Magic	> 200
Minima	> 210

> 172

Cubby

> 216

chiusure speciali - special closing

Tirare

pull

Ribalta

bottom-hinged

Vasistas

vasistas

Botola

ceiling trapdoor

Specifiche tecniche

technical specification

> 225

Finiture

Finishes

> 238

Maniglie

Handles

> 246

**Il sistema
battente B-Line
lascia alle
soluzioni raso muro
ampia libertà
nelle dimensioni
e nell'estetica.**

—
Swing system B-Line leads
to flush doors solutions wide choice
on dimensions and aesthetics.

B-Line

Battente
swing door

Anta Plana
Plana door

Anta Twist
Twist door

Anta Wall
Wall door

Anta Dual
Dual door

Anta Queen
Queen door

Anta King
King door

—

B-Line Anta Plana | Battente

Plana door | Swing system

Più stile alla complanarità della porta

L'anta Plana si inserisce negli spazi abitativi come parte integrante dell'arredamento in diverse finiture: la matericità del gres, la naturalezza dei legni naturali o colorati, la modernità dei laccati opachi e lucidi e il pregio di finiture speciali come pietra, specchio, ecocuoio e Alutes.

More style to door complanarity

Plana door fits into living spaces as integrated part of furnishing in different finishings: Gres materiality, essence of natural or colored woods, modernity of matt and glossy lacquered and value of special finishings like stone, mirror, ecoleather and alutes.

APERTURA battente/singola e doppia
PORTA spingere/tirare
ALTEZZA da 2000 a 3400 mm

—
OPENING swing/single and double
DOOR push/pull
HEIGHT from 2000 to 3400 mm



La porta raso muro arreda la parete unendo alla sua essenzialità strutturale la capacità espressiva dei materiali di pregio. La matericità del gres effetto pietra o marmo, ad esempio, integra la porta nella parete come un elemento di continuità estetica per creare una superficie unica oppure come inserto prezioso per distinguerla nello stile.

High quality material enhance door and ambient.

Flush door decorate the wall unifying to its structural essence the communicative ability of quality materials. Gres materiality in stone effect or marble, for instance, integrate the door into the wall as aesthetic continuity element to create a single unique surface or as a precious insert detail in a distinguished style.

**Materiali
pregiati
valorizzano
porta e stanza.**



B-Line con boiserie
L 900 x H 3000 mm
GR09 Piasentina



B-Line con boiserie
L 800 x H 2700 mm
GR04 Gres Noir Desir



B-Line
L 800 x H 2700 mm
GR17
Gres Statuario Lucido | Glossy Statuario Gres

Ci sono soluzioni che rendono originale l'intramontabile fascino del legno e la naturale verticalità della porta. Un esempio è l'anta abbinata a un pannello sopra luce nella stessa finitura: soluzione che arreda la parete creando un piacevole effetto visivo a tutta altezza e infonde il calore di un materiale classico all'interno di un ambiente moderno.

Multiple shades of a wooden door.

There are solutions that makes the timeless charm of wood original. An example can be the door combined to an overpanel in a matched finishing: a solution that decorates the wall creating a pleasant visual effect full-height up to the ceiling and inspire warmth of a classic material inside a modern ambient.

Le diverse sfumature di una porta in legno.



B-Line con sopra luce | with overpanel
L 900 x H 2400 + 1600 mm
 NC01
 Noce Canaletto | American Walnut



B-Line
L 800 x H 2400 mm
FO01
Frassino Oliva | Olive Ash

La finitura in legno della porta non passa inosservata, sfoggia la sua bellezza attraverso nodi e venature e riscalda l'anta della porta raso muro che invece nasconde la struttura nella parete. Ad impreziosirla ulteriormente è il moderno design della maniglia che, a sua volta, si fa notare tracciando sulla superficie una fascia fino a terra nei caldi toni dell'oro e del bronzo.

**Warmth and
Style revealed in details.**

The wooden finishing of the door never goes unnoticed, shows off its beauty through wood grain and "heat up" the flush door that hides its structure inside the wall. Further enrichment is the handle design that draw a line to the ground in warm shades of gold and bronze.

**Il calore
e lo stile
si rivela nei
dettagli.**



Maniglia Infinito H 1050 mm finitura Bronzato
Handle Infinito H 1050 mm Bronzed finishing

Ricavata nello spessore dell'anta, con il suo design lineare ed ergonomico, questa maniglia assolve con grande stile tutta la sua funzionalità. Garantisce una presa pratica e facile e allo stesso tempo decora l'anta della porta, lasciando libertà di scelta tra tre misure diverse e differenti finiture per il profilo esterno.

A perfectly integrated handle. Obtained from the door thickness, with its linear and ergonomic design, this handle perform with style all its functionality. Grants a precise grip and enriches the door in the same time, leaving freedom of choice between three different measures and finishings for the external profile.

**Una
maniglia
perfettamente
integrata.**



**Maniglia M-1050 finitura
Laccato Metallizzato Nichel e Rovere Scuro**
Handle M-1050
Metal Nickel Lacquered and Dark Oak



B-Line
L 800 x H 2400 mm
RS01
Rovere Scuro | Dark Oak

B-Line
L 800 x H 2700 mm
RL24
Rovere Laccato Piombo | Lead Lacquered Oak





B-Line
L 800 x H 2700 mm
RA01
Rovere Antico | Antique Oak



B-Line
L 800 x H 2100 mm
FM07
Frassino Matè Antracite | Matè Ash Anthracite



B-Line
L 800 x H 2100 mm
FM05
Frassino Matè Marrone | Matè Ash Brown



**Finiture
metallizzate
arredano
ambienti
moderni.**

Il carattere sofisticato dell'effetto metallizzato si fonde qui con la modernità delle superfici laccate: l'incontro di stile ideale per far diventare le porte protagoniste indiscusse degli ambienti. La luce è il tassello finale che completa il quadro estetico: entra in contatto con la superficie e restituisce visivamente un piacevole gioco di riflessi.

Metal finishings decorate modern ambients.

The sophisticated nature of metal finishing blends with surfaces lacquered modernity: Ideal match of style to let the doors become the ambient protagonists. Light is the final piece that complete the aesthetic look: touching the surfaces and creating games of reflections





Questa porta raso muro battente a due ante simmetriche a tutta altezza apre e chiude gli spazi ampi e non solo, raddoppia la praticità e lo stile che caratterizzano la porta. L'essenzialità visiva è interrotta dal design minimale delle maniglie, elementi funzionali e decorativi che tracciano sulle superfici delle ante un segno distintivo.

Symmetrical doors double the comfort and style.

This double symmetrical flush swing door full-height up to the ceiling, opens and closes wide spaces and not only, it doubles the comfort and style that distinguish the door. Visual minimalism of handles, comfort and decorative elements give to the surfaces a sign of distinction.

**Le ante
simmetriche
raddoppiano
praticità e stile.**



Maniglia Infinito H 200 mm finitura Nero Opaco
Handle Infinito H 200 mm Matt Black finishing

B-Line
L 900 + 300 x H 2700 mm
LO21
Laccato Opaco Salvia | Sage Matt Lacquered



Tutta la raffinatezza di una soluzione filo soffitto, senza stipite, è la soluzione per estendere lo spazio di apertura della porta ed il suo carattere. L'anta rifinita con la modernità dei laccati a seconda del colore, scuro o chiaro, e della finitura, opaca o lucida, arreda con la sua semplicità e linearità mondi totalmente diversi ma ugualmente stilosi.

**Door style
extended full-height.**

Sophistication of an up to the ceiling solution, without jamb, is the way to extend the door opening space and its temper. Refined door with lacquered modernity dark or light and finishing matt or glossy, decor with ease and linearity different but equally stylish worlds.

**Lo stile
della porta
si estende a
tutta altezza.**



B-Line
L 800 x H 2700 mm
LO24
Laccato Opaco Piombo | Lead Matt Lacquered



B-Line
L 900 x H 2700 mm
LL01
Laccato Lucido Bianco | White Glossy Lacquered

B-Line
L 800 x H 2700 mm
LL01
Laccato Lucido Bianco | White Glossy Lacquered



B-Line Anta Plana | Sistema Folding

Plana door | Folding system

Anta pieghevole per soluzioni salvaspazio

La versione folding è il sistema di apertura ideale quando lo spazio negli ambienti è ridotto. L'anta pieghevole si presenta divisa in due parti: quando è aperta entrambe si ripiegano su sé stesse senza creare ingombro all'interno della stanza, mentre quando è chiusa si allineano in modo complanare con la parete quasi a scomparire.

Folding door for save-space solutions

Folding versions is an ideal opening system when the ambient spaces are tight/small. Folding door is split in two parts: when opened both parts bends without creating additional bulk inside the room, when closed the parts are aligned with the wall and almost disappears.



B-Line libro | folding
L 800 x H 2400 mm
Pittura Porta/Parete | Painted Door/Wall



B-Line
L 800 x H 2400 mm
LV22
Vetro Laccato Marrone | Brown Lacquered Glass



NEOCLASSIC
PALAZZO SPINI FERONI

La porta in vetro laccato si inserisce nella parete con la discrezione di una soluzione filo muro e arreda la stanza con l'eleganza dei toni scuri, come il marrone dell'anta e il nero della maniglia. A rendere luminosa la porta è la finitura lucida che gioca con la luce e restituisce l'immagine dell'ambiente che la circonda.

**Dark and glossy shades
for elegant ambient.**

The glass lacquered doors are integrated discreetly inside the wall with a flush system solution that decor with dark shades the room, like the brown of the door and the black of the handle. The glossy lacquered finishing gives shine to the door that plays with light and returns it back to the environment.

**Tonalità
scure e
lucide per
ambienti
eleganti.**



Maniglia Holly finitura Bronzato
Handle Holly Bronzed finishing



B-Line
L 800 x H 2700 mm
LV10 Vetro "Vintage" Laccato Ardesia | Slate Lacquered Glass "Vintage"
FO01 Frassino Oliva - Boiserie | Olive Ash - Boiserie

Una particolare texture a rilievo rende vibrante la superficie in vetro della porta. L'alternarsi di sottili scanalature crea un effetto ondulato sull'anta, un accorgimento estetico piacevole alla vista e al tatto. Integrata in una parete materica effetto legno, onde e venature si fondono per arredare la stanza, ognuno con le sue specificità, nel segno della naturalezza e della dinamicità.

**Flush doors
nice to sight and touch.**

A particular embossed texture give vibes to the glass door surface. The alternation of thick grooves creates a wavy effect on the door, a fine aesthetic trick to touch and look. Integrated into a wooden effect, wall, waves and grain melt together to decor the room, each of them with its specific characteristics in the sign of dynamism.

**Porte
raso muro
belle alla vista
e al tatto.**



Maniglia Lieve finitura Cromo Satinato
Handle Lieve Chrome Satin finishing



B-Line
L 800 x H 2400 mm
R07
Eco-cuoio Testa di Moro | Eco-leather Dark Brown



Rivestita dell'eleganza dell'ecocuoio, la porta valorizza la parete e gli ambienti aggiungendo un tocco dal gusto raffinato. Disponibile in diversi colori, per coordinarsi con l'arredo e creare il giusto abbinamento con la maniglia, la porta ecocuoio è completata da cuciture a contrasto, che esprimono e sottolineano l'attenzione ai dettagli di BluInterni nella cura sartoriale.

Eco-leather for couture-style doors.

Wrapped with eco-leather elegance, the door enhances the walls and the environments adding a touch of refined taste. Available in several colors to be matched with interiors and create the right combination with the handle, the eco-leather door is completed with stitches in contrast underlining the attention of details by BluInterni.

Ecocuoio per porte in stile couture.



Finitura Ecocuoio con cuciture a contrasto
Eco-leather with stitches in contrast



Maniglia Chic finitura Cromo Satinato con fondino Ecocuoio Testa di Moro
Handle Chic Chrome Satin with Dark Brown Eco-leather insert



B-Line
L 800 x H 2400 mm
R12
Ecocuoio Beige | Eco-leather Beige

Diverse sono le possibilità stilistiche per far convivere la porta in perfetta armonia con l'arredamento, lo dimostra la finitura ecocuoio qui nei toni neutri e delicati del beige che riveste anta e maniglia coordinandosi. Il minimalismo della porta è impreziosito dalla precisione delle cuciture che disegnano dei riquadri sull'anta mentre il carattere della maniglia è evidenziato e racchiuso da un profilo in metallo cromato.

Door and handle wrapped, coordinated and refined.

Many are the stylish possibilities to match the door in perfect harmony with interiors, demonstrated by eco-leather finishing in neutral delicate shades of beige that wraps the door and handle. Minimalism of door is enhanced by the stitches precision that design squares on the panel while the insert of the handle is encased by a metal chrome profile.

**Porta
e maniglia
rivestite,
coordinate
e rifinite.**



Maniglia Chic finitura Cromo Satinato con fondino Ecocuoio Beige e cuciture in tinta
Handle Chic Chrome Satin with Beige Eco-leather insert

Le porte con ante in vetro specchiato riflettono lo stile della casa e danno unicità ad ogni ambiente, moltiplicano lo spazio e amplificano la luce. L'anta a specchio, in finitura bronzo o argento, garantisce una resa estetica di grande impatto visivo e infonde nell'ambiente atmosfere eleganti e ricercate.

The Charm of mirror surfaces. Doors with mirrors reflect the house style and gives unicity to every ambient, multiplying the space and amplifying the light. Mirror door, in bronze or silver finishing grant a great visual look giving to the environment elegant atmospheres.

Il fascino delle superfici specchiate.



B-Line
L 800 x H 2700 mm
 SP02
 Specchio Bronzo | Bronzed Mirror

Una soluzione filo muro che riflette perfettamente l'estetica e la funzionalità. L'anta a specchio si inserisce con il suo minimalismo nella parete della stanza: funzionalmente è una porta che garantisce riservatezza e sicurezza grazie al sistema di chiusura con nottolino, esteticamente invece offre la comodità di uno specchio a figura intera.

Mirror door,
much more than a simple door. A flush door solution that reflect perfectly its aesthetic and functionality. The mirror door with its minimalism integrates itself inside the wall: functionally it's a door that grant privacy and safety thanks to a latch lock system and aesthetically offers the utility of a full-size mirror.

**Anta a specchio,
molto più
di una porta.**



**Maniglia Edra con chiusura nottolino
finitura Cromo Lucido**
Handle Edra with latch lock Chrome Glossy

B-Line
L 800 x H 2400 mm
SP01
Specchio Argento | Silver Mirror





B-Line
L 700 x H 2400 mm
PO01
Pietra Ocean | Ocean Stone

Le finiture speciali Bluinterni esprimono tutta la bellezza della materia e rivestono porte a diverse altezze. La pietra, con una divisione regolare in pannelli quadrati o rettangolari con o senza sopra luce o in versione a tutta anta, interpreta con accenti diversi la sua matericità ricoprendo la porta con effetti decorativi in linea con le moderne tendenze dell'interior design.

**The rough
pleasantness of stone.**

The special finishings Bluinterni express the beauty of the material applied to different sizes of doors. The stone, with a regular division of squared or rectangular panels with or without overpanel or in full-panel version covers the door with decorative effect aligned to interior design trends.

**La
piacevolezza
ruvida
della pietra.**



Maniglia Holly finitura Nero Opaco
Handle Holly Matt Black finishing



B-Line
L 800 x H 2700 mm
QD50
Alutes Square Bronzo | Bronze



**Trame
luminose
per
impreziosire
lo stile.**

Raffinati effetti decorativi introducono tra le pareti fiori in rilievo, motivi geometrici tridimensionali e riflessi di seta che materializzano l'idea della luce. Sono le particolari trame dei rivestimenti parte della gamma Alutes, che trasformano le porte filo muro in elementi d'arredo da utilizzare ma anche da ammirare.

**Bright textures
to enrich the style.**

Refined decorative effects with embossed flowers, geometric 3D designs and silk reflects and materialize the idea of light. The particular textures of Alutes turn flush doors into interior elements to admire.



B-Line
L 800 x H 3400 mm
SK20
Alutes Silk Oro | Gold

B-Line Anta Twist | Battente

Twist door | Swing system

Due finiture diverse per uno stile unico

L'anta Twist nasce dall'abbinamento di due finiture che unendosi tra loro creano un unico complemento d'arredo. L'anta realizzabile in legno, laccato e vetro laccato è caratterizzata da un inserto decorativo verticale, disponibile nelle stesse finiture dell'anta e in versione specchio, ecocuoi, pietra, Alutes e Impact.

Two different finishings for one style

Twist door born from the combination of two finishings creating a unique interior item. The door in wood, lacquered or lacquered glass is characterized by a decorative vertical insert, available in the same door finishings or in mirror, eco-leather, stone, Alutes and Impact versions.

FINITURE ANTA TWIST

Twist door finishes

Anta | Door

Legni | Woods

Laccati | Lacquers

Vetri Laccati | Lacquered Glasses

Inserto | Insert

Legni | Woods

Vetri Laccati | Lacquered Glasses

Specchio | Mirror

Alutes

Impact

Vintage



B-Line Twist
L 800 x H 2400 mm
LO20 Laccato Opaco Nuvola | Cloud Matt Lacquered
NC01 Noce Canaletto - Insetto Multiriga-H
American Walnut - Multiriga-H Inset



B-Line Twist
L 800 x H 2700 mm
NC01 Noce Canaletto | American Walnut
LM33 Laccato Metallizzato Nichel - Insetto |
Nickel Metallic Lacquered - Insert



Il calore del legno accostato alla freschezza del laccato, classicità e modernità convivono. La verticalità della porta gioca sul contrasto tra le venature del Noce Canaletto e la lucentezza del laccato metallizzato: una scelta dal gusto particolarmente elegante che trova la sua massima espressione in una soluzione a tutta altezza.

**A matching
that show off the elegance.**

The warmth of wood combined with lacquered freshness, classic and modern coexist. Verticality of door plays with contrast of American walnut grain and gives shine to the metal lacquered: a particular elegant choice that finds its best expression in a full-height solution.

**Un
abbinamento
che mette
in scena
l'eleganza.**



Inserto anta Twist finitura Laccato Metallizzato Nichel
Insert door Twist finishing Metal Nickel Lacquered

B-Line Twist
L 800 x H 2700 mm
LV10 Vetro Laccato Ardesia | Slate Lacquered Glass
LO10 Laccato Opaco Ardesia - Inserto Multiriga-V
Slate Matt Lacquered - Multiriga-V Insert



Una porta la cui diversità di stile si tocca veramente con mano. La superficie liscia dell'anta è arricchita da un inserto verticale effetto ondulato che crea un piacevole contrasto visivo e tattile. Protagonista del decorativo è la particolare finitura Multiriga-V, che scolpisce nella fascia dell'anta il pregio di una lavorazione verticale cannettata.

Visual effects

union and haptic contrast.

A door where you can touch its diversity. The smooth surface of this door is enriched with a vertical insert wavy effect that create a pleasant look and haptic contrast. Protagonist is the Multiriga-V a particular finishing, that highlight the band a vertical multy stripes wavy effect.

Unione di effetti visivi e tattili a contrasto.



Inserto anta Twist
finitura Multiriga-V Laccato Ardesia
Twist door effect Multiriga-V Slate Lacquered



Maniglia Edra finitura Cromo Satinato con chiave
Handle Edra Chrome Satin with key

Vetri, specchi e finiture dal mood materico riempiono di stile la fascia dell'anta Twist per garantire una resa estetica di grande impatto.

Come l'inserto in vetro bianco per un look total white adatto a tutti i tipi di spazi e ambienti, o la particolare finitura Impact nei toni del bronzo per chi desidera un gusto più ricercato.

Decorative inserts for any style.

Glasses, mirrors and finishings with materic mood fill of style the Twist door bend to grant an aesthetic impact. Like the white glass insert for a total white look suited to all spaces and environments, or Impact finishing in bronze shades for a refined taste.

Inserti decorativi per ogni tipo di stile.

B-Line Twist

L 800 x H 2400 mm

LO01 Laccato Opaco Bianco | White Matt Lacquered

LV01 Vetro Bianco - Inserto | White Glass - Insert







B-Line Twist
L 800 x H 2400 mm
LO04 Laccato Opaco Crema | Cream Matt Lacquered
SL01 Impact Bronze - Inserto | Impact Bronze - Insert

B-Line Anta Wall | Battente

Wall door | Swing system

Il lato mimetico della porta filo muro

Rivestita con carta da parati o colorata nei toni della parete in cui si inserisce per un effetto di continuità senza interruzioni, il design raso muro dell'anta Wall si mimetizza fino a scomparire risultando perfettamente integrato nello stile della parete.

The Mimetic side of a flush door

Covered by wallpaper or colored with wall shades for a continuity effect with no interruptions, the flush wall design of Anta wall camouflage itself disappear perfectly integrated with the wall style.



B-Line Wall
L 800 x H 2700 mm
Carta da parati/ Pittura Porta/Parete
Wallpaper/ Painted Door/Wall



B-Line Anta Dual | Battente

Dual door | Swing system

La cornice inquadra la leggerezza del vetro

L'anta Dual abbina con originalità il vetro lucido o satinato a una cornice in laccato opaco o legno, nelle tipologie Rovere e Noce. Oltre ad essere funzionale nella divisione degli spazi, questa porta diventa decorativa e conferisce un mood moderno all'ambiente.

The frame square the lightness of glass

Dual door combine with distinctiveness the glossy or satin glass with a frame in matt lacquered or wood as Oak or Walnut. In addition to its functionality in spaces division, this door becomes decorative and gives a modern mood to the ambient.

FINITURE ANTA DUAL

Dual door finishes

Cornice | Frame

Legni | Woods

Laccati | Lacquers

Anta | Door

Vetri | Glasses



Nel sistema B-line la cornice è parte integrante dell'anta: racchiude su tutti i lati la leggerezza del vetro, proposta in diverse colorazioni e sfumature, e si coordina con lo stile dell'ambiente. Il risultato è una porta "finestrata" che si presa come soluzione ideale per illuminare e alleggerire gli spazi di una stanza.

**Flush swing doors
light and bright.**

In B-Line system the frame is totally integrated with the door. Encase all sides the lightness of the glass, proposed in multiple colors and shades and coordinated with the environment. The result is a "windowed" door, an ideal solution to light up and brighten a room.

**Porte
filo muro
battenti leggere
e luminose.**



B-Line Dual

L 800 x H 2400 mm

LO15 Laccato Opaco Canapa | Hamp Matt Lacquered
VV02 Extrachiario Satinato | Satin Extraclear



Extrachiaro Trasparente | Transparent Extraclear

Grigio Trasparente | Transparent Smoked



Bronzo Trasparente | Transparent Bronze

B-Line Dual
L 800 x H 2400 mm
LO10 Laccato Opaco Ardesia | Slate Matt Lacquered
VG01 Grigio Trasparente | Transparent Smoked



B-Line Anta Queen | Battente

Queen door | Swing system

Le geometrie caratterizzano la superficie dell'anta

L'anta Queen pantografata si caratterizza per un particolare effetto bugnato che si propone in tre diverse versioni. Un motivo decorativo che arricchisce di stile il minimalismo della porta raso muro.

Geometries features the door surface

Queen door pantographed enhanced by a particular ashlar effect proposed in three versions. A decorative look that enrich with style the flush door minimalism.

SETTORI ANTA QUEEN

Sectors Door Queen

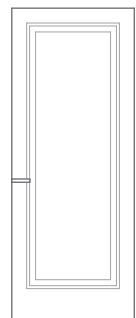

Queen-1
settore | sector

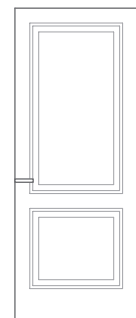

Queen-2
settori | sectors

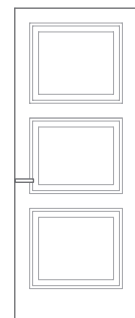

Queen-3
settori | sectors



B-Line Queen-3
L 800 x H 2400 mm
LO01
Laccato Opaco Bianco | White Matt Lacquered



Le bugne, dal sapore prettamente classico, sono gli elementi che determinano lo stile di questa anta pantografata, che qui integra tutta la sua classe nella modernità di una soluzione filo muro. Eleganti geometrie spezzano quindi la linearità delle pareti e trasformano i frontali dell'anta in scenografiche sezioni a uno o più riquadri.

Lines and geometries between modern and classics.

Ashlars with classic taste are elements that define the style of this pantographed door, here it integrate all its class and modernity in a flush solution. Elegant geometries break the linearity of walls and turn the door fronts into scenographic sections with one or more squares.

**Linee e geometrie
tra moderno e classico.**



B-Line Queen-1
L 800 x H 2400 mm
 LO01
 Laccato Opaco Bianco | White Matt Lacquered

B-Line Anta King | Battente

King door | Swing system

Le linee incidono il carattere della porta

L'anta King è l'alternativa alla versione bugnata, si caratterizza per la presenza di incisioni che decorano finemente la superficie in tre modi diversi, per poter scegliere liberamente quella che più si adatta allo stile dei vostri ambienti.

Lines engraves the features of the door

Door King is the alternative to the Ashlars version, it's featured engravings that decors the surface in three different ways, to choose with freedom the one that suits better with the environments style.

INCISIONI ANTA KING

Incisions Door King

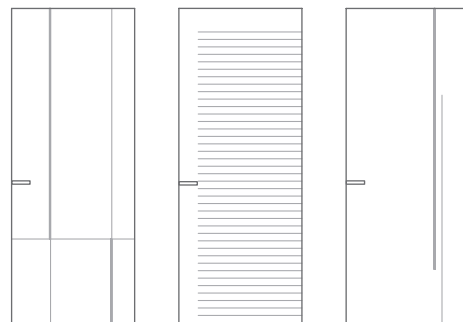

King-1

King-2

King-3



B-Line King-1
L 800 x H 2400 mm
LO01
Laccato Opaco Bianco | White Matt Lacquered



Le linee percorrono e attraversano la superficie liscia dell'anta, orizzontalmente e verticalmente, e incrociandosi tra loro la rendono viva creando delle sezioni incise di diversa forma, grandezza e profondità. È una porta che lascia il segno e lo spazio alla creatività, ampliandoli ovviamente nella versione a tutta altezza.

**Decor born
by crossing of lines.**

Lines run and cross the smooth door surface, horizontally and vertically, crossing and creating engraved sections in different shapes and deepness. It's a door that leave the mark let space to creativity obviously enhanced in the full-height version.

**Il decoro
che nasce
da incroci
di linee.**



Anta con incisione King-1
Door with King-1 incision

B-Line King-2
L 800 x H 2500 mm
LO24
Laccato Opaco Piombo | Lead Matt Lacquered





Maniglia Infinito Minimal finitura Nero Opaco
Handle Infinito Minimal Matt Black finishing

**Linee
semplici
ma di grande
impatto.**

L'anta è minimale nella struttura e nella pantografatura che la caratterizza. Il decoro in questo caso trova forza espressiva nell'estrema semplicità di un segno grafico come la linea, qui proposta in successione per tutta l'altezza della porta e alla cui perfezione grafica si unisce a completare lo stile il design della maniglia, anch'esso lineare ed essenziale.

**Simple lines
but with great personality.**

The Door is minimal in its structure and pantography. Decor in this case take strength and expression in the extreme simplicity of a graphic sign like a simple line, here proposed sequentially full-height. In addition to that, the handle style complete an essential and linear design.

In questa soluzione la pantografatura modella il decoro sull'anta giocando con lo spessore delle incisioni per creare dinamismo e un contrasto visivo e tattile tra i due motivi. Entrambi i decori nascono da una delle estremità dell'anta ma restano sospesi: diversi nella forma la percorrono in modo uguale, parallelamente senza mai raggiungere il lato opposto.

Engravings and Bas-reliefs reinforce the decor. With this solution the pantography model the door decor playing with the thickness of engravings to recreate dynamism and a touchable visual contrast between the looks. Both decors comes from one of the edges but remains suspended: different in shapes, they run it in the same way in parallel without reaching the opposite edge.

Incisioni e bassorilievi rafforzano il decoro.



Il sistema B-Frame incornicia la classicità dell'apertura battente e il minimalismo delle soluzioni raso muro.

—

B-Frame system frames the swing door
classicism and the flush solutions minimalism.

B-Frame

Battente
swing door

Anta Plana
Plana door

Anta Twist
Twist door

Anta Dual
Dual door

Anta Queen
Queen door

Anta King
King door

—

B-Frame Anta Plana | Battente

Plana door | Swing system

La cornice sottolinea la presenza della porta

L'anta Plana nella versione con telaio B-Frame completa il sistema battente con l'aggiunta di cornice e stipite dallo spessore sottile, disponibili in diverse finiture. A differenza della versione B-Line, l'altezza consentita della porta è minore, ovvero fino a 3000 mm anziché 3400 mm.

The frame underlines the door presence

Door plana in B-Frame version completes the swing system with the add of a thin frame and jamb, available in many finishings. Unlike the B-Line version, the maximum door height is lower, up to 3000 mm instead of 3400 mm.

APERTURA battente/singola e doppia
PORTA spingere/tirare
ALTEZZA da 2000 a 3000 mm

—
OPENING swing/single and double
DOOR push/pull
HEIGHT from 2000 to 3000 mm



B-Frame
L 800 x H 2700 mm
RL25
Rovere Laccato Ghiaccio | Ice Lacquered Oak





**Le venature
arredano
anta e cornice
della porta.**

Lo stile della porta è coordinato nei toni del legno Noce Canaletto che scalda con naturalezza l'atmosfera degli ambienti aprendo le porte a soluzioni dal gusto classico e contemporaneo. La bellezza senza tempo delle venature ripercorre e marca la verticalità della superficie per dare alla porta un aspetto ancora più slanciato.

**Wood grain
decors door and frame.**
Door style is coordinated in American Walnut shades that warm the environments atmosphere bringing classic and contemporary taste solutions. The timeless beauty of grain enhances the verticality of the surface and gives to the door a slender look.

B-Frame
L 800 x H 2400 mm
NC01
Noce Canaletto | American Walnut

Le battenti della collezione B-Frame, classiche o raso muro, personalizzano gli spazi con i colori laccati, in versione opaca e lucida, per coordinare le porte con l'arredamento. E per uno stile più delicato, l'alternativa alla forza del colore resta la purezza e l'intramontabile eleganza del bianco, che si adatta a tutti i tipi di spazi e ambienti in modo diverso.

The modernity of matt and glossy lacquered. Swing doors of B-Frame collections, classic or flush, give personality to spaces with lacquered colors, in matt or glossy versions, to coordinate the doors with the rest of the interiors. For a delicate style, the opposite to the strength of the color, remains the pureness and the timeless elegance of white, that adapts to all kind of spaces and environments in different ways.

**La
modernità
dei laccati
opachi e lucidi.**



B-Frame
L 900 x H 2700 mm
LO21
Laccato Opaco Salvia | Sage Matt Lacquered



B-Frame
L 800 x H 2700 mm
LO20
Laccato Opaco Nuvola | Cloud Matt Lacquered

B-Frame Anta Queen | Battente

Queen door | Swing system

Bugne e telaio B-Frame, cornici nella cornice

L'anta Queen è tra le soluzioni pantografate disponibili nel sistema con telaio B-Frame. Le bugne determinano, anche in questo caso, la divisione dell'anta battente in sezioni attraverso tre diverse modalità ma in aggiunta trasferiscono il fascino del decoro fino alla cornice.

Ashlars and frame B-Frame, frames inside the frame

Door Queen is one the pantographed solutions available in system with frame B-Frame. Ashlars define the division of the swing door traditionally in sections through three different ways adding decor charm to the frame.

SETTORI ANTA QUEEN

Sectors Door Queen

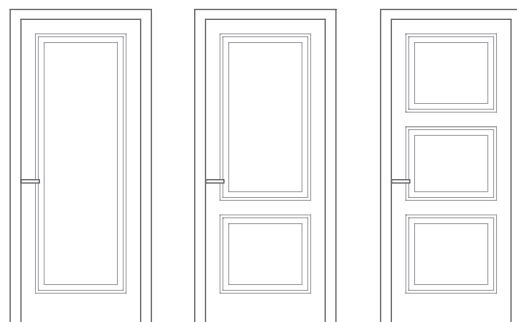

Queen-1
settore | sector

Queen-2
settori | sectors

Queen-3
settori | sectors



B-Frame Queen-2
L 800 x H 2400 mm
LO01
Laccato Opaco Bianco | White Matt Lacquered





Anta Queen battente con Stipite-Queen
Swing door Queen with Stipite-Queen jamb



Anta bugnata Queen-2 con maniglia Luce/02 quadra finitura Cromo Lucido
Door Queen-2 with ashlar and handle Luce/02 quadra finishing Glossy Chrome

**La boiserie
riveste con la
stessa finitura
porta e parete
per creare stanze
dalle superfici
continue
e coordinate.**

—
Boiserie covers with the same
finishing door and wall to create rooms
with coordinate surfaces

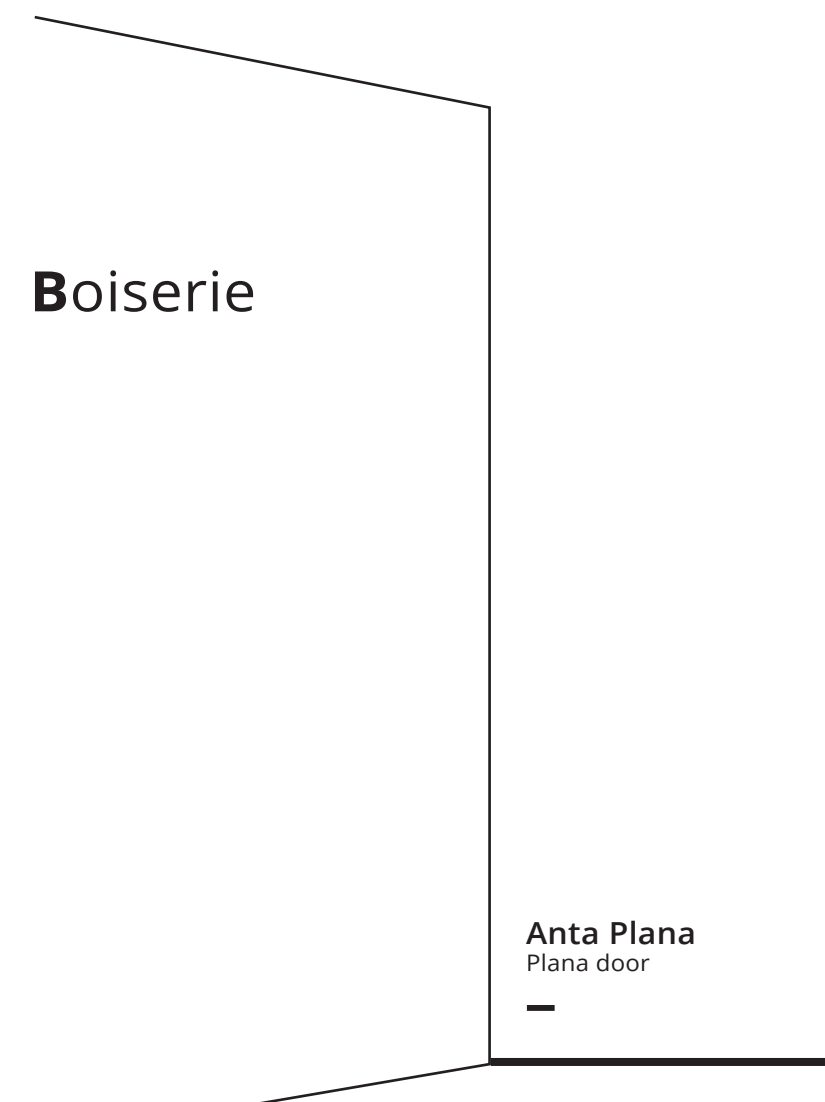

La boiserie è sistema di rivestimento a pannelli, dal formato verticale o orizzontale, che permette di coordinare porta e parete nella stessa finitura. Il risultato è un ambiente che esalta l'estetica dei materiali e uniforma lo stile, personalizzabile nelle numerose finiture dell'anta Plana, che spaziano dagli effetti materici ai legni, dai laccati ai rivestimenti dai particolari effetti decorativi.

Total look for coordinate environments.

Boiserie is a system of wall covering with panels, vertical or horizontal shape, that permits to coordinate door and wall in the same finishing. The result is an ambient estetically enhanced with materials and unified style, customizable in numerous finishings of Plana from materic effects to woods, from lacquered to coatings.

**Total look
per ambienti
coordinati.**



Boiserie
RN01
Rovere Naturale | Natural Oak





Boiserie
FM06
Frassino Matè Tabacco | Matè Ash Tobacco

Boiserie
LL01
Laccato Lucido Bianco | White Glossy Lacquered



Boiserie
GR08
Emperador Extra



La boiserie avvolge le pareti della stanza e della porta, rivestendole in diverse espressioni di stile. Per ottenere una perfetta complanarità tra porta e parete nelle composizioni con boiserie la porta battente è integrata con il telaio raso muro B-Line e completata da un profilo in alluminio in finitura laccata o in tinta che rafforza la struttura e anche il concetto di cura dei dettagli.

Style that change the room and the opening.

The Boiserie wraps the room walls and the door, coating in different expressions of style. To reach a perfect match between wall and door in compositions with boiserie, the swing door is integrated with frame flush B-Line and completed by an aluminum profile in lacquered finishing or in color that reinforce the structure and the attention to details concept.

**Lo stile
che cambia
la stanza e
l'apertura.**



Boiserie con anta Plana battente
Boiserie with Plana swing door

Boiserie
PO01
Pietra Ocean | Ocean Stone



**Il sistema
a bilico offre
molteplici possibilità
progettuali
dalla notevole resa
estetica per le
grandi aperture.**

—
Pivot system offers multiple project possibilities with outstanding aesthetic look for wide openings.

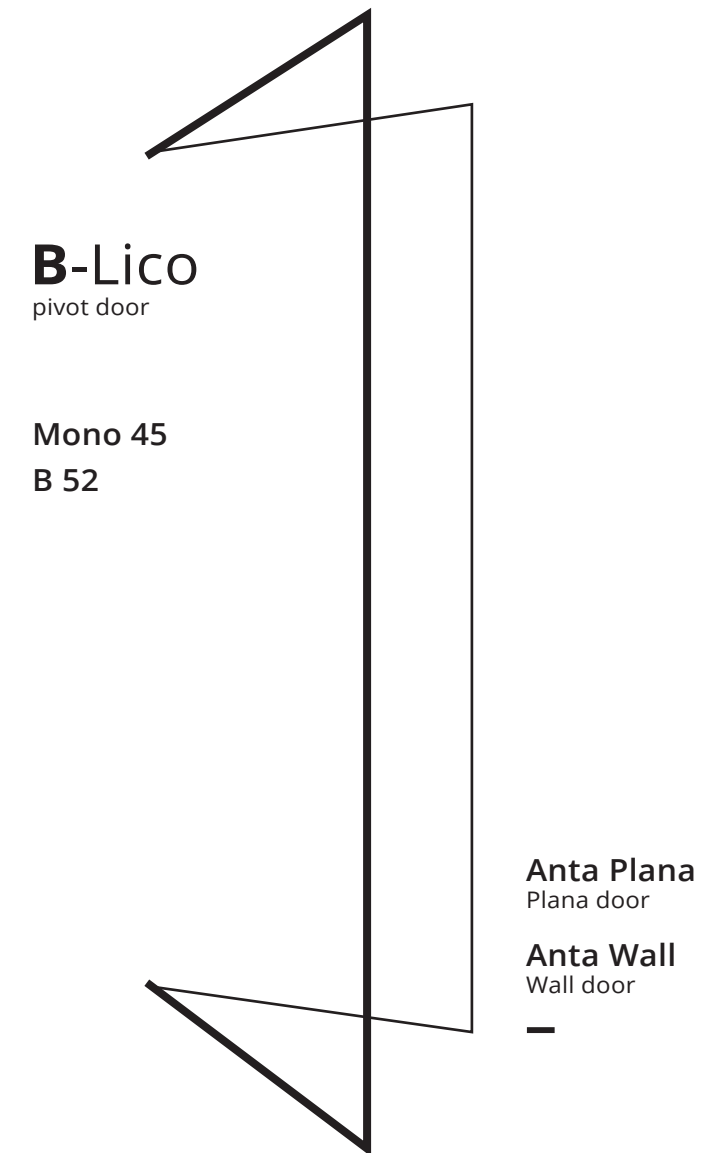

B-Lico Anta Plana | Bilico

Plana door | Bilico system

Pratiche aperture per spazi non convenzionali

L'anta Plana caratterizza lo stile delle porte raso muro Bluinterni con sistema a bilico, differenziandole in due tipologie per lo spessore dell'anta e per il meccanismo di apertura: monodirezionale (Mono 45) e bidirezionale (B 52).

Practical openings for unconventional spaces

Door Plana enhances the flush door style Bluinterni with pivot system, distinguishing in two types in terms of door thickness and opening mechanism: Monodirectional (Mono 45) and Bidirectional (B52).

B 52

APERTURA bilico
PORTA bidirezionale
ALTEZZA fino a 3000 mm

OPENING pivot
DOOR bidirectional
HEIGHT up to 3000 mm

MONO 45

APERTURA bilico
PORTA spingere/tirare monodirezionale
ALTEZZA fino a 3000 mm

OPENING pivot
DOOR push/pull monodirectional
HEIGHT up to 3000 mm





B-Lico B 52 con sopra luce | over panel
L 1250 x H 2700 + 800 mm
LO24
Laccato Opaco Piombo | Lead Matt Lacquered

Il sistema B-Lico allarga gli orizzonti della porta e apre nuovi spazi. In legno o nei colori laccati, a specchio o con effetti decor risolve con originalità la divisione degli ambienti importanti. Oltre ai molteplici rivestimenti disponibili, contribuiscono a fare la differenza nello stile le maniglie che variano per modello, finiture e applicazione a scelta tra esterna o integrata nell'anta.

Finishings and dimensions for wide openings.

System B-Lico broaden horizons of doors and open new spaces. In wooden or in lacquered colors, mirrors or with decor effects, solves with originality the division of important environments. In addition to multiple coatings available, finishings and coverings makes the difference in style of the handles.

Finiture e dimensioni per grandi aperture.



Maniglia M-1050 finitura Laccato Opaco Piombo
Handle M-1050 Lead Matt Lacquered finishing



Apertura B-Lico B 52 bidirezionale
Bidirectional B-Lico B 52 opening

B-Lico B 52
L 1000 x H 2700 mm
Pittura porta | Painted door





**La porta
ruota e
apre gli spazi.**

La porta B 52, come i mm del suo spessore, unisce la finitura naturale del Rovere Antico di grande eleganza a un'apertura moderna di grande praticità. Si tratta del sistema a bilico bidirezionale che fa ruotare l'anta attorno a un perno su entrambi i lati, destra e sinistra: movimento che riduce l'ingombro dell'anta e aumenta la comodità nell'apertura.

The door rotates and opens the spaces.

Door B52, referred to the mm of thickness, combine the charm of the natural oak antique to a modern practical opening. It's the bidirectional Pivot system that let the door rotate around a pivot on both sides left and right: this movement reduce the door obstruction and amplify the comfort of the opening.

B-Lico B 52
L 1250 x H 2700 mm
RA01
Rovere Antico | Antique Oak

Nella versione monodirezionale della porta bilico il movimento è unilaterale e lo spessore dell'anta è minore, ovvero 45 mm. Ogni elemento strutturale del meccanismo di movimento è nascosto per far sembrare la porta dal design raso muro parte integrante della parete, solo dettagli di stile come la maniglia ne evidenziano la presenza.

Maximum opening full-height.
In monodirectional version of pivot door the movement is unilateral and door thickness is less, 45mm. Every structural element of movement mechanism is hidden to let the door look a flush door wall-integrate, only style details like the handle underline its presence.

**Massima
apertura e a
tutta altezza.**

B-Lico MONO 45
L 1250 x H 2700 mm
NC01
Noce Canaletto | American Walnut



Il sistema di apertura B-Move è tanti modi di scorrere e più tipologie di ante per una casa in movimento.

—
Opening system B-Move is
“many ways of sliding” and “many types of doors”
for a “house on the move”.

B-Move

Scorrevole
sliding door



Sistema di scorrimento
Sliding system

SKY

BASIC

LUCE-B / LUCE-S

MULTY / MAGIC

MINIMA

—

B-Move **Sistema Sky** | Scorrevole

Sky system | Sliding system

APERTURA scorrevole
PORTA singola/doppia e binario incassato
ALTEZZA da 2000 a 3400 mm

—
OPENING sliding
DOOR single/double and built-in rail
HEIGHT from 2000 to 3400 mm



B-Move Sky
L 800 + 800 x H 2700 mm
FO01
Frassino Oliva | Olive Ash



B-Move Sky
L 900 + 900 x H 3000 mm
RS01
Rovere Scuro | Dark Oak

Le finiture naturali dei legni, moderne dei laccati o ricercate come l'ecocuio creano sempre la giusta atmosfera e coordinano anche gli elementi all'interno della stanza. Ne è un esempio il Rovere Scuro che accomuna le ante scorrevoli e la boiserie oppure la finitura Nichel della maniglia incassata che si raccorda con il design della mensola retroilluminata.

A sliding door that opens the spaces with style.

Natural finishing of woods, modern in lacquered of particular like eco-leather create always the right mood and coordinate all elements inside the room. For example the Dark Oak that combine the sliding doors to a boiserie or the Nichel finishing of a built-in handle matched with a backlit shelf.



Mensola in Laccato Metallizzato Nichel
Shelf in Nickel Metal Lacquered

**Uno
scorrevole
che apre gli
spazi con stile.**



Maniglia M-400 finitura Laccato Metallizzato Nichel e Rovere Scuro
Handle M-400 Nickel Metal Lacquered and Dark Oak finishing

B-Move Sky
L 1800 x H 2700 mm
LO20
Laccato Opaco Nuvola | Cloud Matt Lacquered







**Pareti
mobili per
stanze che
comunicano.**

L'anta singola, come nel caso delle doppie, scorre in modo fluido esterna alla parete senza lasciare a vista meccanismi ma sempre con la possibilità di dare forma a scenografiche soluzioni a tutta altezza. Personalizzabile nelle dimensioni, nelle finiture e nella scelta del tipo di maniglia.

**Movable walls for
communicating rooms.**

Single door, like double, slide fluidly external to the wall with invisible mechanisms and always with the possibility to give shape to full-height solutions. Customizable in dimensions, finishings and handle choice.



B-Move Sky
L 900 x H 2600 mm
R12
Ecocuoio Beige con cuciture Beige | Eco-leather Beige with Beige steaches

B-Move Sistema Basic | Scorrevole

Basic system | Sliding system

APERTURA scorrevole
PORTA singola/doppia e velette
ALTEZZA da 2000 a 3400 mm

—
OPENING sliding
DOOR single/double and cover profile
HEIGHT from 2000 to 3400 mm



B-Move Basic
L 900 x H 2700 mm
LO15
Laccato Opaco Canapa | Hemp Matt Lacquered

L'eleganza contemporanea del movimento di questo sistema di scorrimento è incentrata sulle velette. Sono gli elementi strutturali cardine di Basic: coprono il binario agganciato al soffitto o alla parete e permettono alle ante di scorrere in maniera fluida. Personalizzabili nella finitura e abbinabili con l'anta Plana o Twist danno forma a progetti di design di alta resa estetica.

**Doors slides
through cover profiles.**

The contemporary elegance of this system slide movement is focused on cover profiles. Those are structural elements of Basic: covers the hanged to the ceiling rail or to the wall and permits to the doors to slide fluidly. Customizable in finishings and matchable to door Plana or Twist give shape to great aesthetic look projects.

**Le porte
scorrono
attraverso
le velette.**



B-Move Basic
L 900 x H 2400 mm
FM01
Frassino Matè Bianco | Matè Ash White



B-Move Basic Twist
L 1000 + 1000 x H 2400 mm
LO01 Laccato Opaco Bianco
White Matt Lacquered
QD50 Alutes Square Bronzo | Bronze

B-Move Sistema Luce-S / Luce-B | Scorrevole

Luce-S / Luce-B system | Sliding system

LUCE-S

APERTURA scorrevole
PORTA doppia e binario incassato
ALTEZZA da 2000 a 3400 mm

—
OPENING sliding
DOOR single/double and built-in rail
HEIGHT from 2000 to 3400 mm

LUCE-B

APERTURA scorrevole
PORTA doppia e velette
ALTEZZA da 2000 a 3400 mm

—
OPENING sliding
DOOR single/double and cover profile
HEIGHT from 2000 to 3400 mm



B-Move Luce-B
L 2000 x H 2400 mm
RN01
Rovere Naturale | Natural Oak



Un sistema scorrevole con doppio binario.

Una configurazione a più pannelli scorrevoli che si sovrappongono tra loro e scorrono per aprire e chiudere in modo ampio e scenografico lo spazio, con la possibilità di scegliere tra soluzione con binario incassato a soffitto o velette. Proposti nelle finiture laccate si inseriscono nell'arredo e ne diventano vera e propria parte integrante, scelte cromatiche che mettono la porta in primo piano.

A double rail sliding system.
A Multiple doors configuration that overlays between them and slides to open and close wide spaces, with the possibility to choose a built in rail or with cover profiles. Proposed in lacquered finishings are inserted inside the interiors.

B-Move Luce-S
L 2300 x H 2700 mm
LO20
Laccato Opaco Nuvola | Cloud Matt Lacquered



B-Move Sistema Multy / Magic | Scorrevole

Multy / Magic system | Sliding system

MULTY

APERTURA scorrevole
PORTA singola/doppia con
scorrimento a ruote a vista
ALTEZZA da 2000 a 2700 mm

—
OPENING sliding
DOOR single/double with visible
wheels sliding mechanism
HEIGHT from 2000 to 2700 mm

MAGIC

APERTURA scorrevole
PORTA singola/doppia con
binario a scomparsa
ALTEZZA da 2000 a 2700 mm

—
OPENING sliding
DOOR single/double
with hidden rail
HEIGHT from 2000 to 2700 mm



B-Move Multy
L 1000 x H 2500 mm
LL23
Laccato Lucido Navy | Navy Glossy Lacquered

B-Move Multy
L 900 + 900 x H 2200 mm
LO10
Laccato Opaco Ardesia | Slate Matt Lacquered

B-Move Magic
L 1000 x H 2700 mm
RN01
Rovere Naturale | Natural Oak



Sebbene in due diverse modalità, lo scorrimento è generato dalla presenza delle ruote. Nel sistema Multy sono a vista, oltre ad essere elementi funzionali diventano anche decorativi. Nel sistema Magic, invece, le ruote sono nascoste, perfetto per dare forma a soluzioni pulite e a scomparsa come la porta che si unisce al pannello boiserie nella stessa finitura.

Wheels, elements between functionality and aesthetic.

In two different ways, the sliding is generated by the presence of wheels. In Multy system are visible and decorative. In Magic System are hidden. Perfect for clean solution like doors combined to same finishings as boiserie.

**Ruote,
elementi tra
funzionalità
ed estetica.**





B-Move Magic
L 1000 + 1000 x H 2500 mm
RL02
Rovere Laccato Burro | Butter Lacquered Oak

B-Move Sistema Minima | Scorrevole

Minima system | Sliding system

APERTURA scorrevole
PORTA singola/doppia a scomparsa interno muro
ALTEZZA da 2000 a 2700 mm

—
OPENING sliding
DOOR single/double sliding inside the wall
HEIGHT from 2000 to 2700 mm

B-Move Minima
L 1000 x H 2600 mm
QD10
Alutes Square Argento | Silver



B-Move Minima
L 1200 + 1200 x H 2600 mm
LO01
Laccato Opaco Bianco | White Matt Lacquered





**Lo
scorrevole
che
scompare
nel muro.**

Questa tipologia di scorrevole non crea ingombri e lascia completamente libera la parete. Con la praticità di un semplice gesto la porta si apre e scompare nascondendosi nel muro per lasciare totalmente libero il passaggio tra gli ambienti. Una soluzione moderna, realizzabile a una o due ante, che rende pratico lo scorrimento e ottimizza lo spazio in qualsiasi ambiente.

**Sliding disappearing
inside the wall.**

This sliding system leaves the wall completely free. With a simple touch the door opens and disappears inside the wall leaving a total free passage between spaces. A modern solution, in two or three sliding doors to optimize the space.

**Soluzioni
speciali per
chiudere in maniera
semplice e pulita
gli angoli
salvaspazio
in ogni ambiente
della casa.**

—
Special solution to close in a simple way
the save-space corners.

Cubby

Chiusure speciali
Special closing

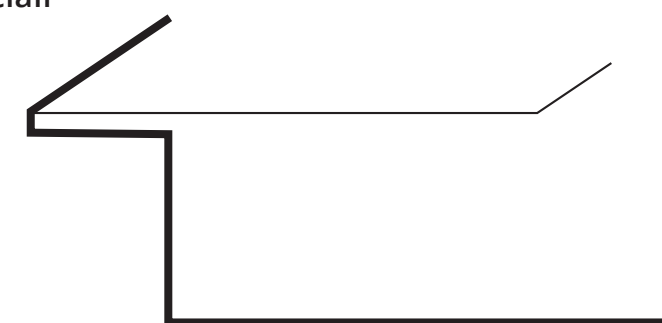

Tirare
Pull

Ribalta
Vottom-hinged

Botola
Ceiling trapdoor

Vasistas
Vasistas



Sistema **Cubby** | Salvaspazio

Cubby | Save-space system

APERTURA
tirare/ribalta/botola/vasistas

—
OPENING
pull/bottom-hinged/ceiling trapdoor/vasistas



Discreti e utili, tecnici o funzionali: sono queste le caratteristiche degli spazi che animano le pareti di casa e che necessitano di essere richiusi in modo pratico, con ante dotate di sistemi push-pull o con chiave. Chiusure per ogni ambiente della casa e adatte ad ogni progetto architettonico come piccole nicchie, armadi in nicchia, ripostigli, sottoscala, quadri elettrici o idraulici.

Customized closing for each space.

Discreet and useful, technical and functional: those are the highlights of spaces that bring to life the house walls and that needs to be openable in a practical way. With push-pull panels or with key. Closures for all type of ambient, niches, wardrobes, closets, switchboards etc...

Ad ogni spazio la sua chiusura.

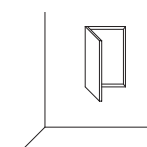

Singolo | Single

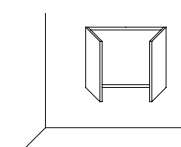

Doppio | Double

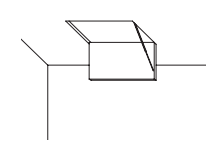

Botola | Ceiling trapdoor

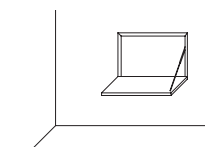

Vasistas | Vasistas

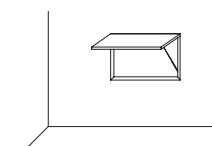

Ribalta | Bottom-hinged

Questi vani salvaspazio sono pensati sempre in funzione alla loro capacità di contenimento e per la praticità, ma meritano anche un'attenzione estetica per integrarsi al meglio nell'ambiente. La possibilità di dipingere o rivestire le diverse tipologie di anta in tinta con la parete e l'invisibilità dei sistemi di chiusura sono tutto ciò che serve per nasconderli con stile.

**Invisible closing
for hidden solutions.**

These save-space compartments are conceived in terms of capacity, functionality and deserve aesthetic attention to be integrated in the best way with the rest of environments. The possibility to paint or cover these compartments are the only things needed to hide them with style.

**Chiusure
invisibili
per soluzioni
nascoste.**

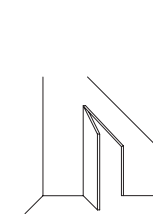

Obliquo | Oblique

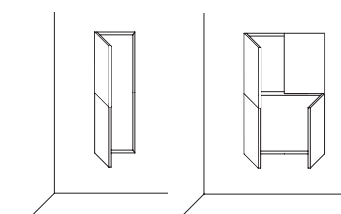

Composizione multipla | Multiple composition

Specifiche tecniche

Technical details

B-Line Battente | Swing system

Anta battente

Struttura raso muro e grande libertà dimensionale in larghezza e in altezza, anche nella soluzione a filo soffitto. B-Line è anche porta a tutta altezza, con o senza traverso, per un effetto di totale linearità tra anta e soffitto.

Swing door

Flush to wall structures and big freedom in both width and height dimensions, even if in ceiling solution. B-Line reaches the ceiling, with or without beam, in order to have a total linearity between door panel and ceiling.

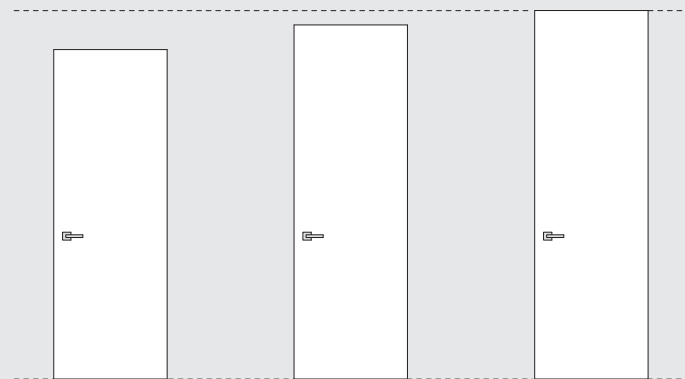

Con traverso
With beam

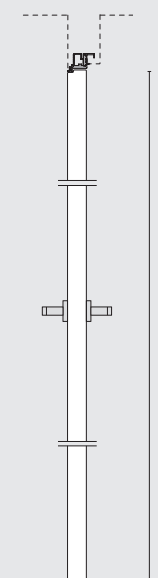

A soffitto
Ceiling

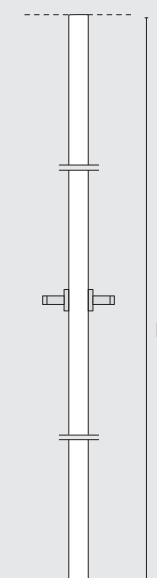

Altezze da 2000 a 3400 mm
Height from 2000 to 3400 mm

Porta a tirare

B-Line a tirare permette un'apertura verso l'esterno, lato in cui è presente il raso muro. L'apertura può essere a destra o a sinistra.

Pull door

B-Line pull door permits an opening toward the outer side, which is the flush side.

Muratura
Brickwall

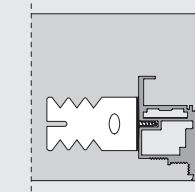

Cartongesso
Plasterboard

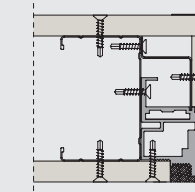

Singola
Single

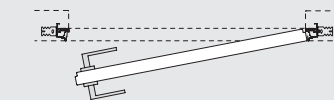

Larghezza da 600 a 1000 mm
Width from 600 to 1000 mm

Doppia
Double

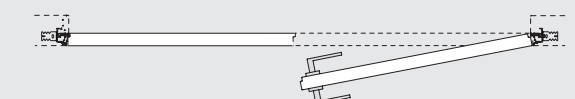

Larghezza da 1200 a 1800 mm
Width from 1200 to 1800 mm

Porta a spingere

B-Line a spingere permette l'apertura con una spinta verso l'interno della stanza. L'apertura può essere a destra o a sinistra.

Push door

B-Line push door permits an opening toward the inner side of the room.

Muratura
Brickwall

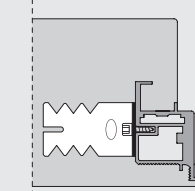

Cartongesso
Plasterboard

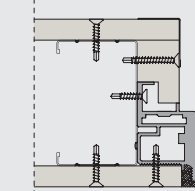

Singola
Single



Larghezza da 600 a 1000 mm
Width from 600 to 1000 mm

Doppia
Double

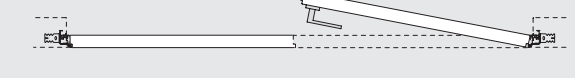

Larghezza da 1200 a 1800 mm
Width from 1200 to 1800 mm

B-Frame Battente | Swing system

Anta battente con stipite

B-Frame è la porta con stipite dallo spessore sottile, che mantiene una perfetta complanarità. L'altezza di B-Frame può arrivare a filo soffitto, con o senza traverso superiore, per combinare lo stipite classico con la modernità delle soluzioni.

Swing door with jamb

B-Frame is the door with a thin jamb. It keeps an alignment. The height of B-Frame can reach the ceiling, with or without the upper beam, in order to match classical jamb to modern solutions.

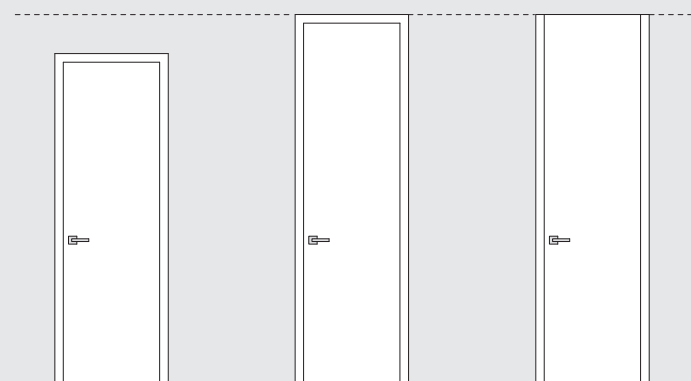

Con traverso
With beam

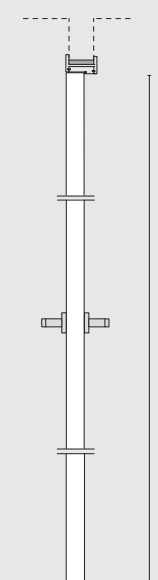

A soffitto
Ceiling

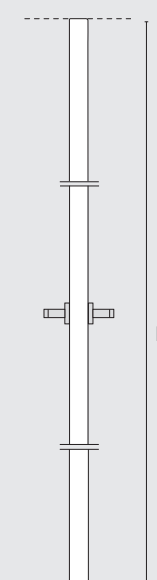

Altezze da 2000 a 3000 mm
Height from 2000 to 3000 mm

Porta a tirare

B-Line a tirare permette un'apertura verso l'esterno, lato in cui è presente il raso muro. L'apertura può essere a destra o a sinistra.

Pull door

B-Line pull door permits an opening toward the outer side, which is the flush side.

Muratura
Brickwall

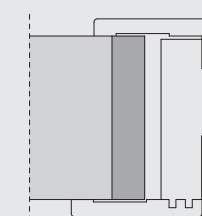

Cartongesso
Plasterboard

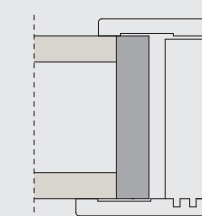

Singola
Single

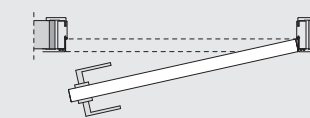

Larghezza da 600 a 1000 mm
Width from 600 to 1000 mm

Doppia
Double

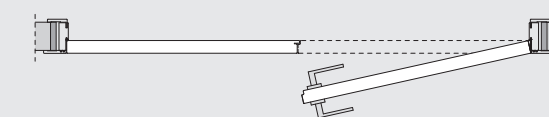

Larghezza da 1200 a 1800 mm
Width from 1200 to 1800 mm

Porta a spingere

B-Line a spingere permette l'apertura con una spinta verso l'interno della stanza. L'apertura può essere a destra o a sinistra.

Push door

B-Line push door permits an opening toward the inner side of the room.

Muratura
Brickwall

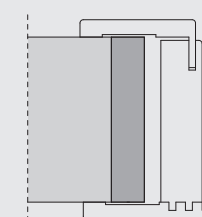

Cartongesso
Plasterboard

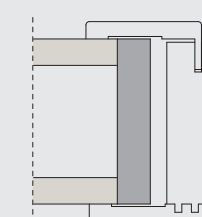

Singola
Single

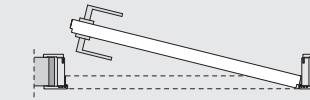

Larghezza da 600 a 1000 mm
Width from 600 to 1000 mm

Doppia
Double

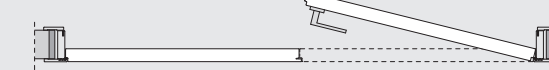

Larghezza da 1200 a 1800 mm
Width from 1200 to 1800 mm

B-Lico Bilico | Pivot door B 52

Anta bilico bidirezionale

B52 con apertura bidirezionale e spessore dell'anta 52 mm ruota attorno al proprio asse verticale e può essere aperta sia verso destra, sia verso sinistra. È disponibile anche a tutta altezza con traverso.

Bidirectional pivot door

B52 with bidirectional opening and thickness of 52 mm turns around its vertical axis and can be opened on both sides, right and left. Bidirectional pivot is available also till the ceiling with beam.

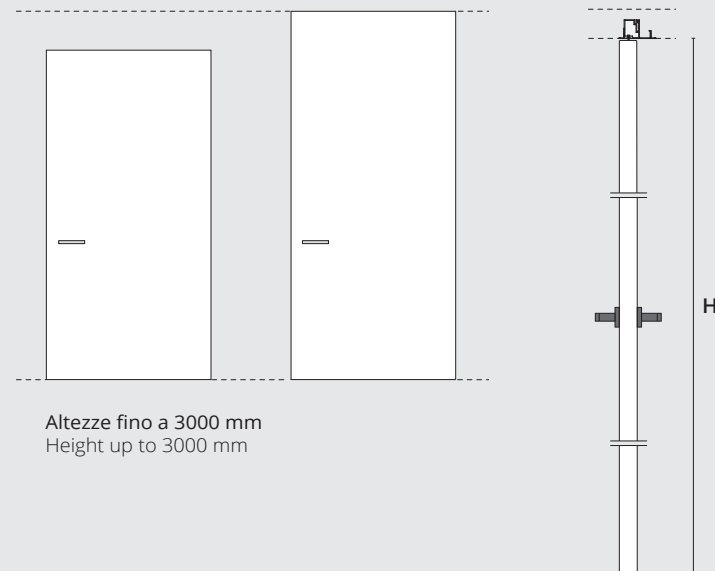

Altezze fino a 3000 mm
Height up to 3000 mm

Porta bidirezionale

L'apertura bidirezionale, sia a tirare che a spingere, permette un maggior controllo degli ambienti mantenendo il concetto di filo muro.

Bidirectional door

Bidirectional opening, both pull and push, permits a better control of spaces, keeping the flush to wall concept.

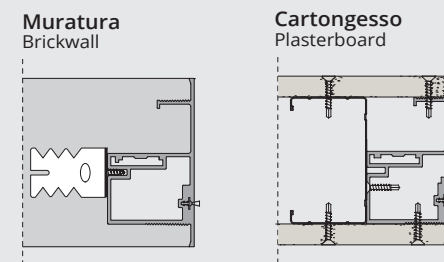

Singola Single

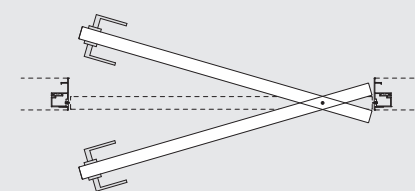

Larghezza fino a 1250 mm
(da 1251 a 1950 a preventivo)
Width up to 1250 mm (from 1251 to 1950 ask for a quotation)

B-Lico Bilico | Pivot door MONO 45

Anta bilico monodirezionale

Porta con apertura monodirezionale e spessore dell'anta 45 mm. È disponibile anche a tutta altezza con traverso.

Monodirectional pivot door

Door with monodirectional opening and thickness of 45 mm. Monodirectional pivot is available also till the ceiling with beam.

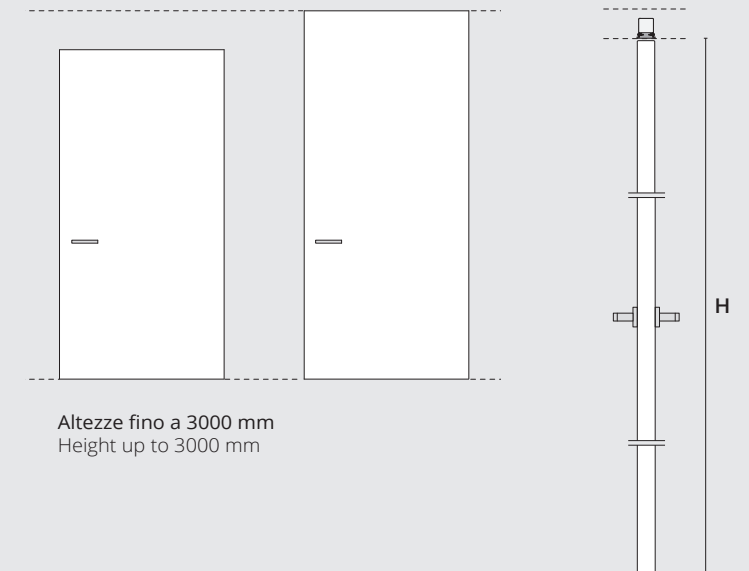

Altezze fino a 3000 mm
Height up to 3000 mm

Porta a tirare

La porta a bilico monodirezionale è disponibile a tirare, con apertura a destra o a sinistra.

Pull door

Door with monodirectional opening, available with pull opening, toward right or left.

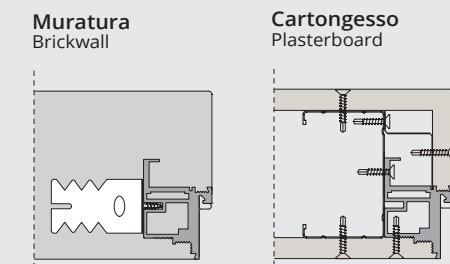

Singola Single

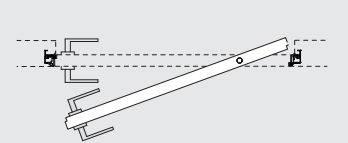

Larghezza da 600 a 1000 mm
Width from 600 to 1000 mm

Porta a spingere

La porta a bilico monodirezionale può essere a spingere, con apertura a destra o a sinistra.

Push door

Monodirectional pivot door can have push opening, toward right or left.

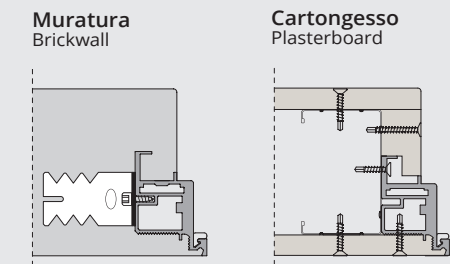

Singola Single

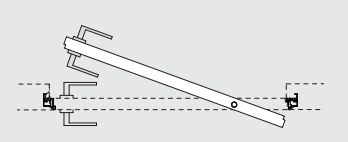

Larghezza da 600 a 1000 mm
Width from 600 to 1000 mm

B-Line telaio Boiserie | anta battente

B-Line frame | swing door Boiserie

Rivestimento per pareti

Boiserie è un sistema per il rivestimento delle pareti realizzato con pannelli in multistrati di okoumè. Si integra perfettamente con il telaio raso muro B-Line e consente di avere una totale complanarità tra porta e boiserie. Il sistema è proposto con pannelli in verticale.

Wall covering

Boiserie is a wall covering system made by panels in okoumè multilayer. It perfectly matches itself with the flush to wall frame B-Line and permits to have a fully complanarity between door and boiserie. The system exists with vertical panels.



Pannello di chiusura bordato
Edged closing panel

Pannello con profilo, in alluminio o laccato in tinta per chiusura terminale
Panel with matched or lacquered aluminum profile for closing



Pannello assemblato a 45° con un lato di dimensione max 150 mm
45° assembled panel with one side maximum dimension 150 mm

Pannello assemblato a 90°
90° assembled panel

Aggancio boiserie su telaio B-Line a spingere

Boiserie hanging on B-Line push frame

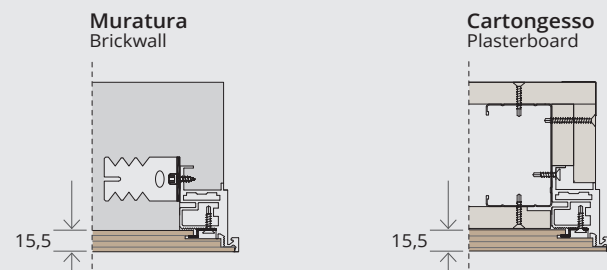

Aggancio boiserie su telaio B-Line a tirare

Boiserie hanging on B-Line pull frame

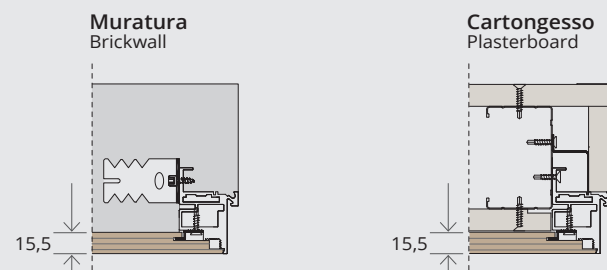

Boiserie Verticale | Vertical Boiserie

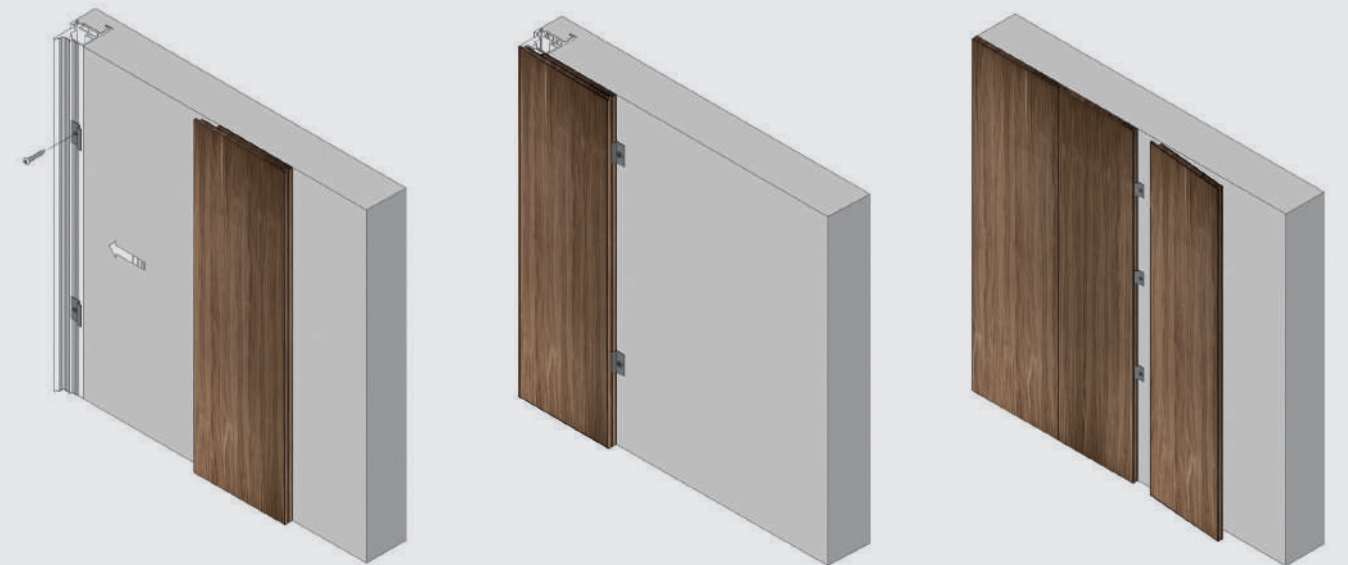

Installazione pannello iniziale
Installation of the starting panel

Ancoraggio pannello iniziale
Anchor of the starting panel

Installazione pannelli successivi
Installation of following panels

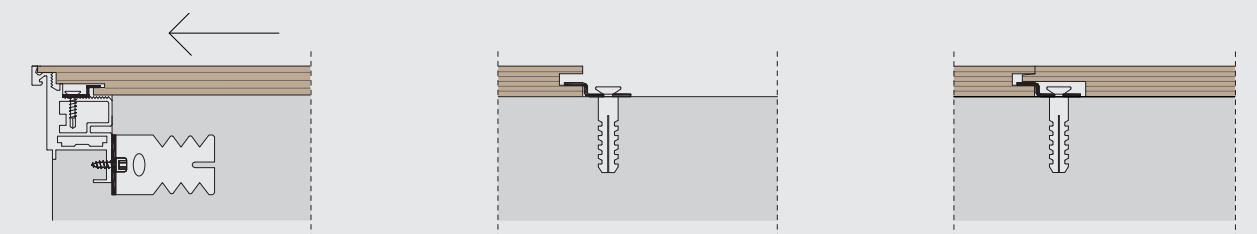

B-Move Scorrevole - Sliding system

Sky

Singola o doppia con binario incassato a soffitto
Single or double sliding door with built-in rail

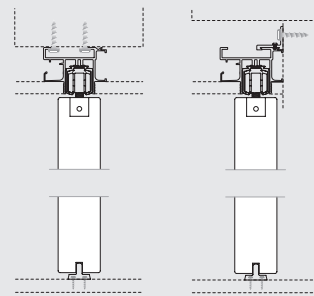
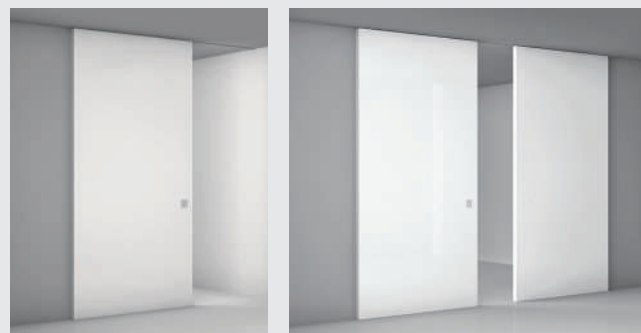

Basic

Singola o doppia con velette
Single or double sliding door with cover-profile

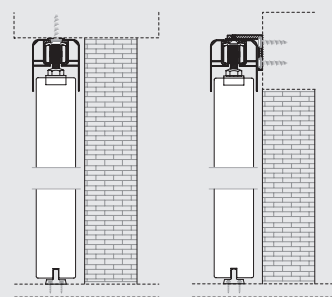

Luce-S

Doppia con binario incassato a soffitto in luce
Double sliding door with built-in rail in the opening

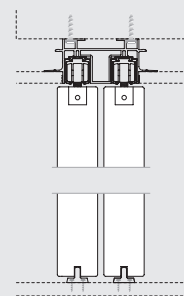
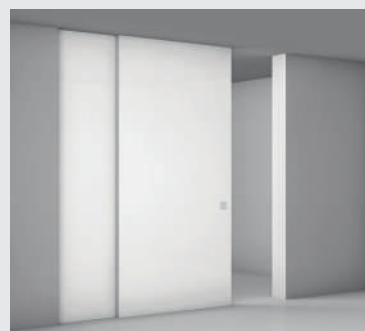

Luce-B

Doppia con velette in luce
Double sliding door with cover-profile into the opening

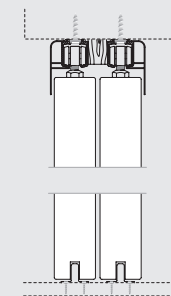

Multy

Singola o doppia con sistema di scorrimento a ruote
Single or double sliding door with sliding system on wheels

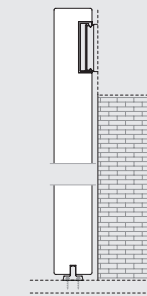
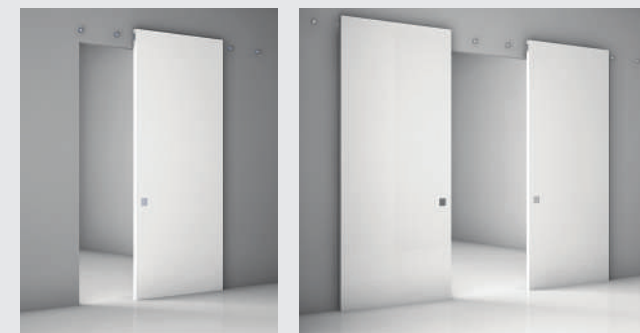

Magic

Singola o doppia con binario a scomparsa
Single or double sliding door with hidden rail

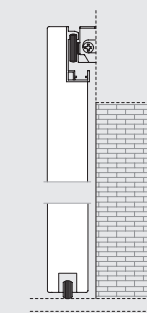
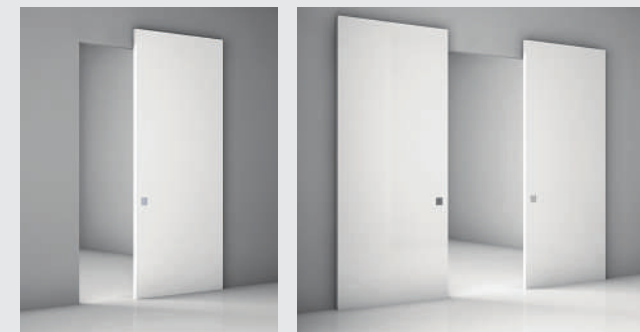

Minima

Singola o doppia a scomparsa interno muro
Single or double sliding door into the wall



Trova con BluInterni la soluzione ideale per dare valore aggiunto all'ambiente di casa o all'ufficio. Scegli lo stile della porta grazie all'ampia selezione di finiture in linea con le tendenze dell'interior design e di materiali di alta qualità che garantiscono solidità, resistenza e bellezza duratura nel tempo.

—
Find with BluInterni the best ideal way and solution to give value to your environments. Choose the doors styles thanks to the wide selections of finishings always in trends with interior designs and high-quality materials that grants solidity, resistance, performace and charm through the years.



Legni | Wood

***NC01** | Noce Canaletto

American Walnut

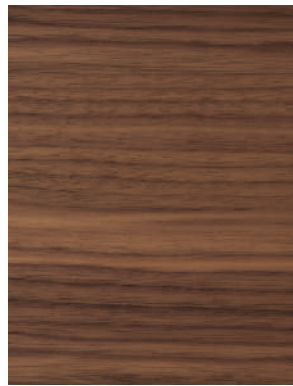

FO01 | Frassino Oliva

Olive Ash



RS01 | Rovere Scuro

Dark Oak

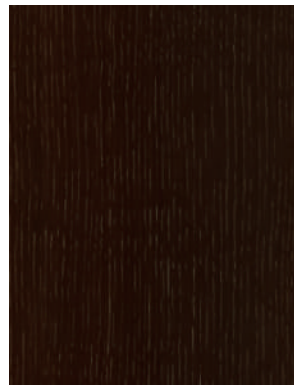

***RN01** | Rovere Naturale

Natural Oak

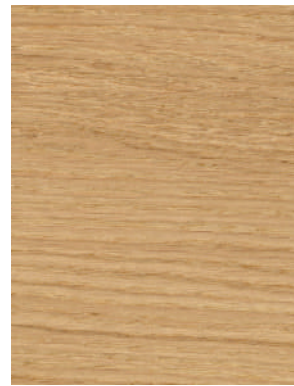

***RA01** | Rovere Antico Naturale

Natural Antique Oak



RC01 | Rovere Artik

Artic Oak



Frassino Matè | Matè Ash

FM01 | Bianco

White



FM05 | Marrone

Brown



FM06 | Tabacco

Tobacco



FM07 | Antracite

Anthracite



* Rovere Laccato | Lacquered Oak

RL01 | Bianco

White



RL02 | Burro

Butter



RL25 | Ghiaccio

Ice



RL20 | Nuvola

Cloud



RL04 | Crema

Cream



RL15 | Canapa

Hemp



RL21 | Salvia

Sage



RL23 | Navy

Navy

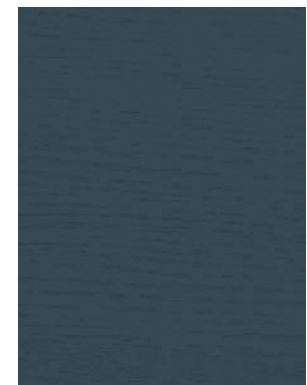

RL24 | Piombo

Lead

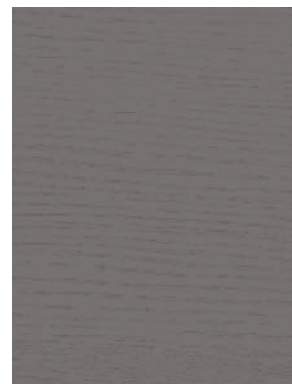

RL10 | Ardesia

Slate



RL22 | Marrone

Brown

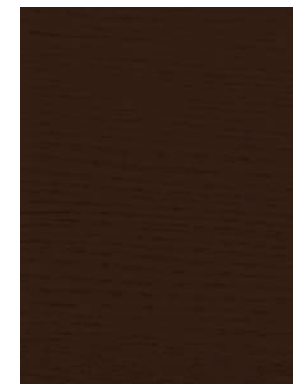

RL12 | Nero

Black

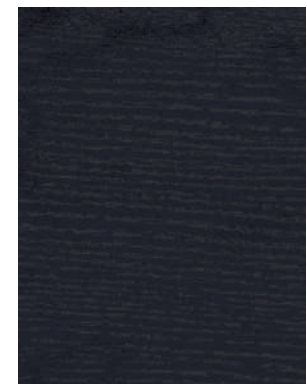

*

Su richiesta la vena può essere verticale | Vertical vein is available upon request

Laccati Opachi e Lucidi | Matt and Glossy Lacquered

LO01 | Bianco Opaco

Matt White

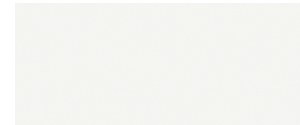

LO02 | Burro Opaco

Matt Butter

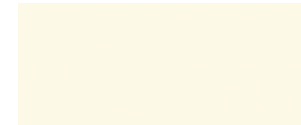

LO25 | Ghiaccio Opaco

Matt Ice

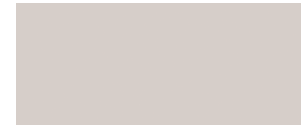

LO20 | Nuvola Opaco

Matt Cloud



LL01 | Bianco Lucido

Glossy White

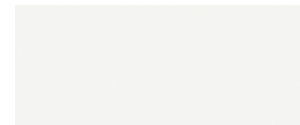

LL02 | Burro Lucido

Glossy Butter

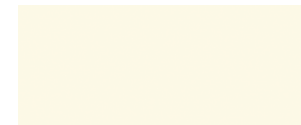

LL25 | Ghiaccio Lucido

Glossy Ice

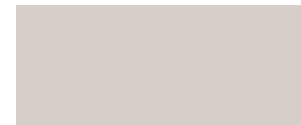

LL20 | Nuvola Lucido

Glossy Cloud



LO04 | Crema Opaco

Matt Cream



LO15 | Canapa Opaco

Matt Hemp



LO21 | Salvia Opaco

Matt Sage



LO23 | Navy Opaco

Matt Navy



LL04 | Crema Lucido

Glossy Cream



LL15 | Canapa Lucido

Glossy Hemp



LL21 | Salvia Lucida

Glossy Sage



LL23 | Navy Lucido

Glossy Navy



LO24 | Piombo Opaco

Matt Lead



LO10 | Ardesia Opaco

Matt Slate



LO22 | Marrone Opaco

Matt Brown



LO12 | Nero Opaco

Matt Black



LL24 | Piombo Lucido

Glossy Lead



LL10 | Ardesia Lucido

Glossy Slate



LL22 | Marrone Lucido

Glossy Brown

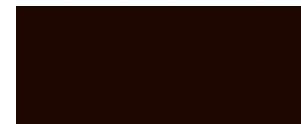

LL12 | Nero Lucido

Glossy Black



Vetri Laccati | Lacquered Glass

SV01 | Bianco Satinato

Satin White



SV02 | Burro Satinato

Satin Butter



SV25 | Ghiaccio Satinato

Satin Ice



SV20 | Nuvola Satinato

Satin Cloud



LV01 | Bianco Lucido

Glossy White



LV02 | Burro Lucido

Glossy Butter



LV25 | Ghiaccio Lucido

Glossy Ice



LV20 | Nuvola Lucido

Glossy Cloud



SV04 | Crema Satinato

Satin Cream



SV15 | Canapa Satinato

Satin Hemp



SV21 | Salvia Satinato

Satin Sage



SV23 | Navy Satinato

Satin Navy



LV04 | Crema Lucido

Glossy Cream



LV15 | Canapa Lucido

Glossy Hemp



LV21 | Salvia Lucida

Glossy Sage



LV23 | Navy Lucido

Glossy Navy



SV24 | Piombo Satinato

Satin Lead



SV10 | Ardesia Satinato

Satin Slate



SV22 | Marrone Satinato

Satin Brown



SV12 | Nero Satinato

Satin Black



LV24 | Piombo Lucido

Glossy Lead



LV10 | Ardesia Lucido

Glossy Slate



LV22 | Marrone Lucido

Glossy Brown



LV12 | Nero Lucido

Glossy Black



Laccati RAL e metallizzati su richiesta | RAL and metallics lacquers upon request

Gres

GR08 | Emperador Extra

Extra Emperador

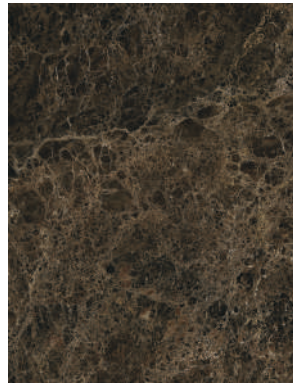

GR03 | Nero Greco

Greco Black

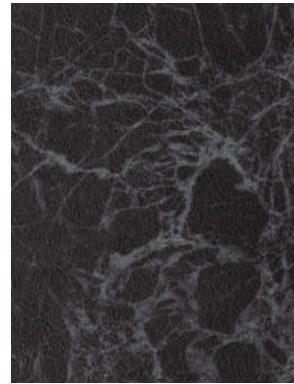

GR04 | Noir Desir Opaco

Matt Noir Desir

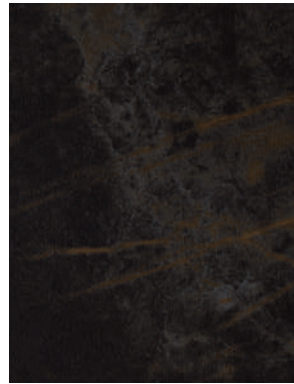

GR14 | Noir Desir Lucido

Glossy Noir Desir

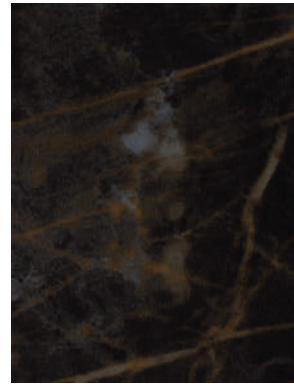

GR07 | Statuario Opaco

Matt Statuario

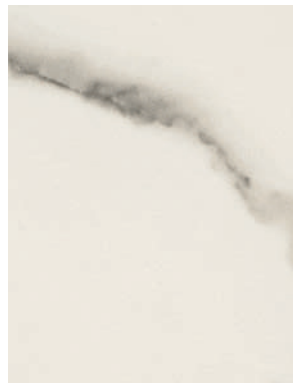

GR17 | Statuario Lucido

Glossy Statuario



GR09 | Piasentina

Piasentina



GR05 | Ossido Bruno

Brown Oxide



Pietra | Stone

PS01 | Shine

Shine



PO01 | Ocean

Ocean

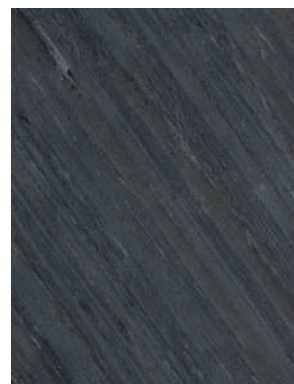

Ecocuoio | Eco-leather

R01 | Bianco

White

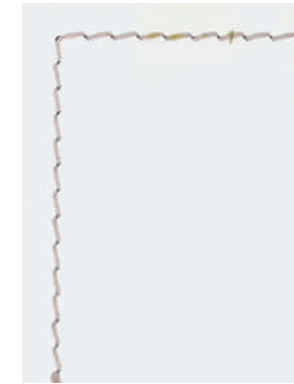

R12 | Beige

Beige



R03 | Marrone

Brown

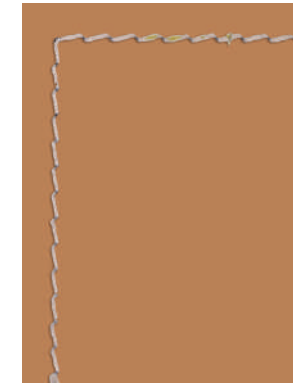

R07 | Testa di Moro

Lead



R04 | Rosso

Red



R10 | Bordeaux

Bordeaux

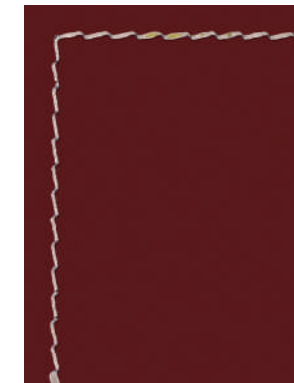

R06 | Blu

Blue



R05 | Grigio

Grey

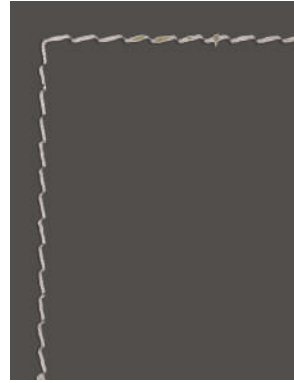

R08 | Nero

Black

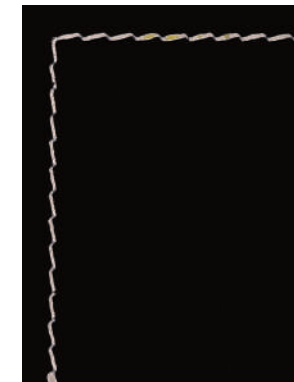

Disponibile cucitura in tinta o a contrasto | Available stitching in contrast or match

Finiture speciali | Special finishing

SL01 | Impact Bronze

Impact Bronze



SL02 | Impact Silver

Impact Silver



SL03 | Vintage Copper

Vintage Cooper



Specchi | Mirrors

SP01 | Argento

Silver



SP02 | Bronzo

Bronze



SP03 | Grigio

Smoked

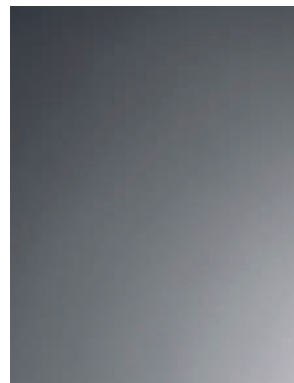

Alutes

QD10 | Square Argento

Silver



QD15 | Square Nichel

Nickel



QD20 | Square Oro

Gold



QD30 | Square Rame

Cooper



QD40 | Square Acciaio

Steel

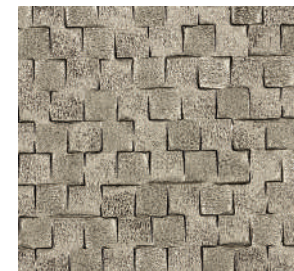

QD45 | Square Titanio

Titanium



QD50 | Square Bronzo

Bronze



QD60 | Square Nero

Black



SK10 | Silk Argento

Silver



SK20 | Silk Oro

Gold



F110 | Fiori Argento

Silver

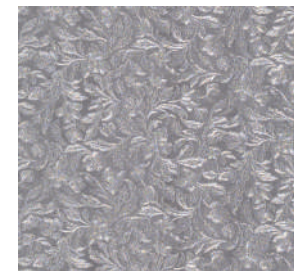

F120 | Fiori Oro

Gold



F160 | Fiori Nero

Black



Maniglie per ante battenti | Handles - swing doors

Chiusura solo maniglia

Handle only



Chiusura chiave

Key lock



Chiusura nottolino

Latch lock



Chiusura Yale

Yale lock



Infinito

H. 1050



IF1050 PCS
Cromo Satinato
Chrome Satin



IF1050 ONO
Nero Opaco
Matt Black



IF1050 OLV
Ottone Lucido
Glossy Brass



IF1050 AB
Bronzato
Bronzed



IF1050T
Con nottolino
With latch

H. 200 Corta|Short



IF200 PCS
Cromo Satinato
Chrome Satin



IF200 ONO
Nero Opaco
Matt Black



IF200 OLV
Ottone Lucido
Glossy Brass



IF200 AB
Bronzato
Bronzed



IF200T
Con nottolino
With latch

Minimale|Minimal



IF01 PCS
Cromo Satinato
Chrome Satin



IF01 ONO
Nero Opaco
Matt Black



IF01 OLV
Ottone Lucido
Glossy Brass



IF01 AB
Bronzato
Bronzed



IF01T
Con nottolino
With latch

Due



DU10 PCS
Cromo Satinato
Chrome Satin



DU10 ONO
Nero Opaco
Matt Black



DU10 PGS
Grafite Satinato
Graphite Satin



DU10 PVD-SG
Oro Antico
Satinato
Antique Gold Satin



DU10T
Con nottolino
With latch

Pluris



RDN 24
Nottolino
Latch



PL01 PCS
Cromo Satinato
Chrome Satin



PL01 ONO
Nero Opaco
Matt Black



PL01 TAN
Antracite
Anthracite



PL01 OBN
Bianco
White

Pure



PUNTO Nottolino
Latch



127001
Cromo Lucido
Glossy Chrome



127001
Cromo Satinato
Chrome Satin



127001
Nero Etna
Etna Black



127001
Bianco Monviso
Monviso White

Lieve



PUNTO Nottolino
Latch



127005
Cromo Lucido
Glossy Chrome



127005
Cromo Satinato
Chrome Satin



127005
Nero Etna
Etna Black



127005
Bianco Monviso
Monviso White

Maniglie per ante battenti | Handles - swing doors

Luce/01 tonda



Luce/02 quadra



Holly



Chic

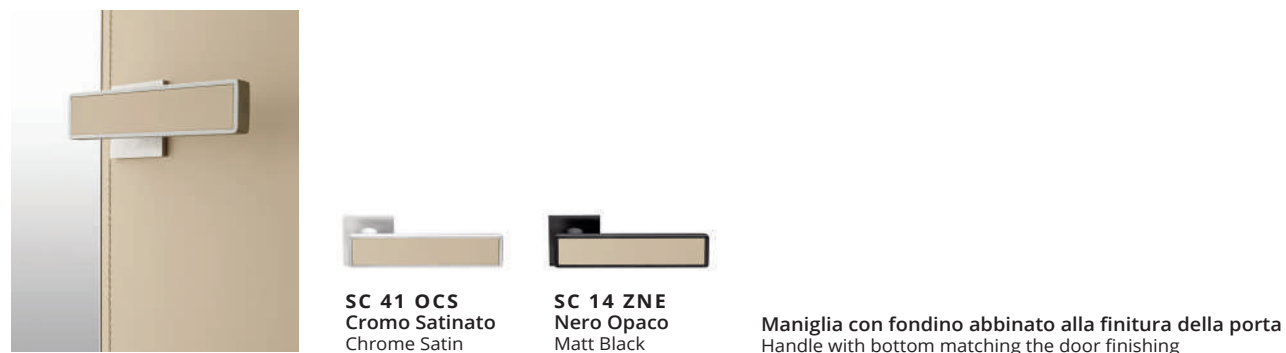

Edra

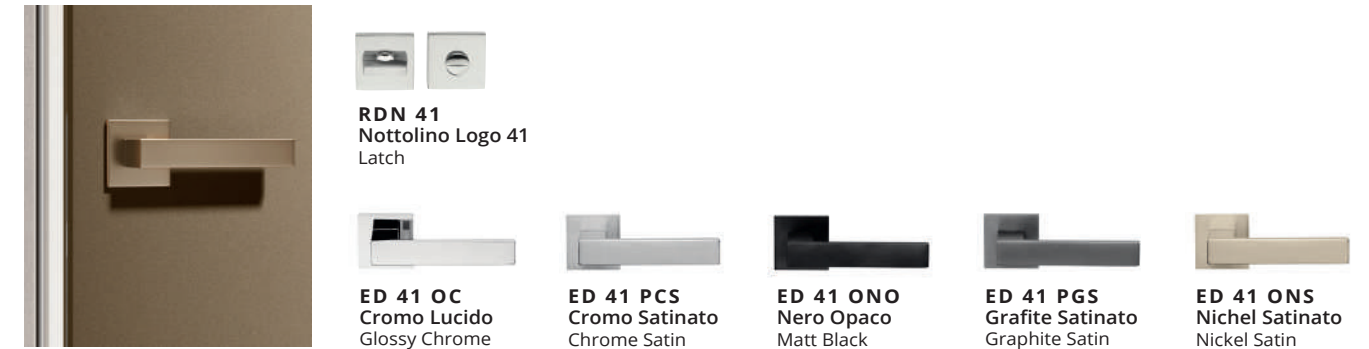

Esa



M-150/M-400/M-1050

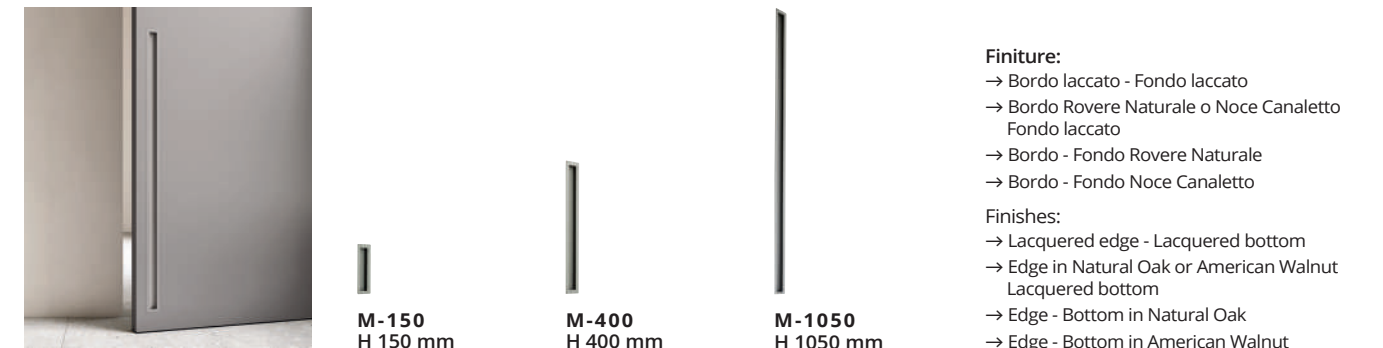

R-10 maniglione / handle

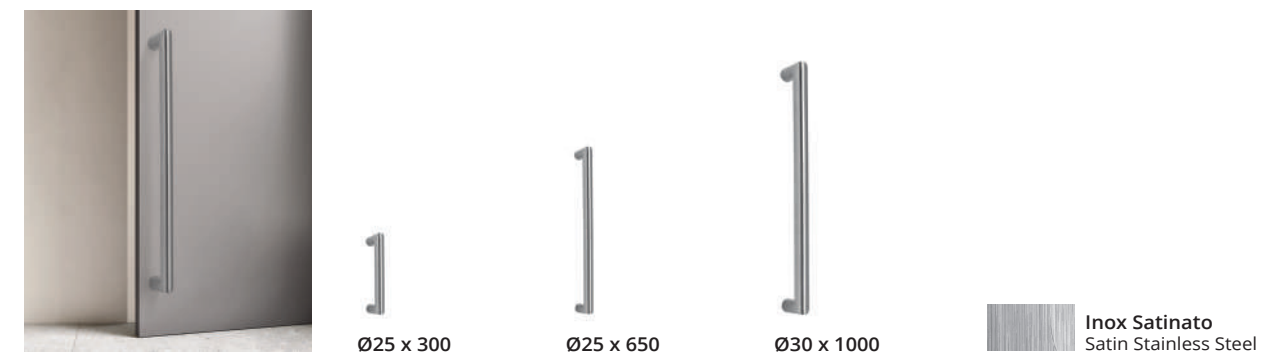

Maniglie per ante scorrevoli | Handles - sliding doors

S-68



S-68
Maniglia
Handle



S-68
Maniglia con fondino abbinato alla finitura della porta
Handle with bottom matching the door finishing

Rondò T-48



SD 202
Maniglia
Handle



SD 205
Maniglia + Chiave
Handle + Key



SD 204
Maniglia + Nottolino
Handle + Latch

	Bianco White
	Nero Black
	Cromo Lucido Glossy Chrome
	Cromo Satinato Chrome Satin
	Bronzo Satinato Bronzed Satin
	Ottone Lucido Glossy Brass

Ring Q-65



SD 222
Maniglia
Handle



SD 223
Maniglia + Chiave
Handle + Key



SD 224
Maniglia + Nottolino
Handle + Latch

	Bianco White
	Nero Black
	Cromo Lucido Glossy Chrome
	Cromo Satinato Chrome Satin
	Bronzo Satinato Bronzed Satin
	Ottone Lucido Glossy Brass

C-09



C-09
Maniglia
Handle

La maniglia C-09 può essere utilizzata anche su porte B-Line a libro, con chiusura Push-Pull o con serratura a rullo.
Handle C-09 can be installed on B-Line folding doors, with Push-Pull or roller lock.

Cromo Satinato
Chrome Satin

M-150/M-400/M-1050



M-150
H 150 mm

M-400
H 400 mm

M-1050
H 1050 mm

Finiture:
→ Bordo laccato - Fondo laccato
→ Bordo Rovere Naturale o Noce Canaletto - Fondo laccato
→ Bordo - Fondo Rovere Naturale
→ Bordo - Fondo Noce Canaletto
Finishes:
→ Lacquered edge - Lacquered bottom
→ Edge in Natural Oak or American Walnut - Lacquered bottom
→ Edge - Bottom in Natural Oak
→ Edge - Bottom in American Walnut

R-10 maniglione / handle



Ø25 x 300

Ø25 x 650

Ø30 x 1000

Inox Satinato
Satin Stainless Steel

concept & graphic design
Lokomotiv

photo & rendering
Indoor

styling
Rossi & Co

colour separation & print
Lucegroup.it

September 2022

BLUINTERNI
ITALIAN ARCHITECTURAL DOORS

FIAM srl
Via Castellana, 15
31010 Cimadolmo (Tv) Italy
T. +39 0422 748839
www.bluinterni.it info@bluinterni.it

FIAM srl
Via Castellana,15
31010 Cimadolmo (TV) - Italy
T. +39 0422 748839
www.bluinterni.it info@bluinterni.it